

TOSHIBA



COMBINATION COLOR TELEVISION AND DVD VIDEO PLAYER

MD20P1

OWNER'S MANUAL

Introduction 2

Connections 13

Basic setup 18

TV operation 20

Basic playback 28

Advanced playback 31

Function setup 38

Others 42

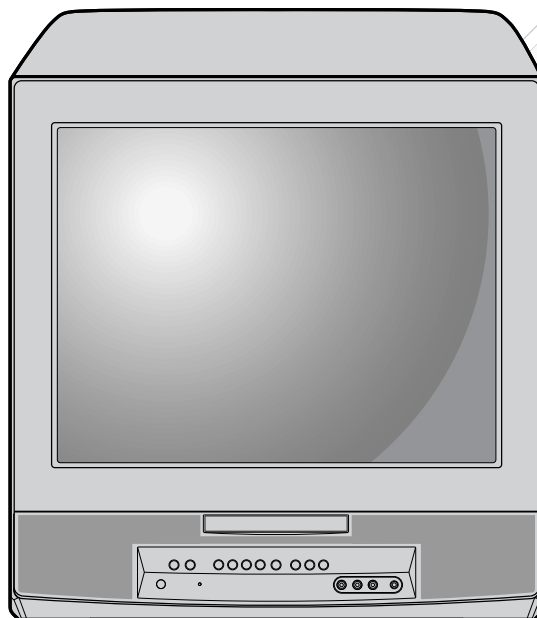

©2004 Toshiba Corporation
Before operating the unit, please read this manual thoroughly.

IMPORTANT SAFEGUARDS



CAUTION
RISK OF ELECTRIC SHOCK
DO NOT OPEN

CAUTION: TO REDUCE THE RISK OF ELECTRIC SHOCK, DO NOT REMOVE COVER (OR BACK). NO USER-SERVICEABLE PARTS INSIDE. REFER SERVICING TO QUALIFIED SERVICE PERSONNEL.



The lightning flash with arrowhead symbol, within an equilateral triangle is intended to alert the user to the presence of uninsulated dangerous voltage within the product's enclosure that may be of sufficient magnitude to constitute a risk of electric shock.



The exclamation point within an equilateral triangle is intended to alert the user to the presence of important operating and maintenance (servicing) instructions in the literature accompanying the appliance.

WARNING: TO PREVENT FIRE OR SHOCK HAZARD, DO NOT EXPOSE THIS APPLIANCE TO RAIN OR MOISTURE.

WARNING: This equipment has been tested and found to comply with the limits for a Class B digital device, pursuant to Part 15 of the FCC Rules. These limits are designed to provide reasonable protection against harmful interference in a residential installation. This equipment generates, uses and can radiate radio frequency energy and, if not installed and used in accordance with the instructions, may cause harmful interference to radio communications. However, there is no guarantee that interference will not occur in a particular installation. If this equipment does cause harmful interference to radio or television reception, which can be determined by turning the equipment off and on, the user is encouraged to try to correct the interference by one or more of the following measures:

- Reorient or relocate the receiving antenna.
- Increase the distance between the equipment and receiver.
- Connect the equipment into an outlet on a circuit different from that to which the receiver is connected.
- Consult the dealer or an experienced radio/TV technician for help.

CAUTION: Changes or modifications not expressly approved by the party responsible for compliance with the FCC (Federal Communications Commission) Rules could void the user's authority to operate this equipment.

COPYRIGHT: It is permissible to record television programs, films, video tapes and other material only in the event that third party copyrights and other rights are not violated.

CAUTION:
THIS DIGITAL VIDEO PLAYER EMPLOYS A LASER SYSTEM.

TO ENSURE PROPER USE OF THIS PRODUCT, PLEASE READ THIS OWNER'S MANUAL CAREFULLY AND RETAIN FOR FUTURE REFERENCE. SHOULD THE UNIT REQUIRE MAINTENANCE, CONTACT AN AUTHORIZED SERVICE LOCATION-SEE SERVICE PROCEDURE.

USE OF CONTROLS, ADJUSTMENTS OR THE PERFORMANCE OF PROCEDURES OTHER THAN THOSE SPECIFIED HEREIN MAY RESULT IN HAZARDOUS RADIATION EXPOSURE.

TO PREVENT DIRECT EXPOSURE TO LASER BEAM, DO NOT TRY TO OPEN THE ENCLOSURE. VISIBLE LASER RADIATION MAY BE PRESENT WHEN THE ENCLOSURE IS OPENED. DO NOT STARE INTO BEAM.

Location of the required Marking

The rating sheet and the safety caution are on the rear of the unit.

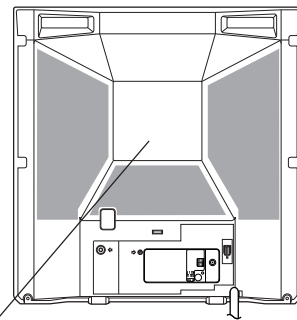

CERTIFICATION: COMPLIES WITH FDA RADIATION PERFORMANCE STANDARDS, 21 CFR SUBCHAPTER J.

1. READ INSTRUCTIONS

All the safety and operating instructions should be read before the unit is operated.

2. RETAIN INSTRUCTIONS

The safety and operating instructions should be retained for future reference.

3. HEED WARNINGS

All warnings on the unit and in the operating instructions should be adhered to.

4. FOLLOW INSTRUCTIONS

All operating and use instructions should be followed.

5. CLEANING

Unplug this unit from the wall outlet before cleaning. Do not use liquid cleaners or aerosol cleaners.

Use a damp cloth for cleaning the exterior cabinet only.

6. ATTACHMENTS

The manufacturer of this unit does not make any recommendations for attachments, as they may cause hazards.

7. WATER AND MOISTURE

Do not use this unit near water. For example, near a bathtub, washbowl, kitchen sink, laundry tub, in a wet basement, or near a swimming pool.

8. ACCESSORIES

Do not place this unit on an unstable cart, stand, tripod, bracket, or table.

The unit may fall, causing serious injury, and serious damage to the unit.

- 8A.** An appliance and cart combination should be moved with care. Quick stops, excessive force, and uneven surfaces may cause the appliance and cart combination to overturn.

9. VENTILATION

Slots and openings in the cabinet back or bottom are provided for ventilation, and to ensure reliable operation of the unit, and to protect it from overheating.

These openings must not be blocked or covered. The openings should never be blocked by placing the unit on a bed, sofa, rug, or other similar surface. This unit should never be placed near or over a radiator or heat source. This unit should not be placed in a built-in installation such as a bookcase or rack unless proper ventilation is provided or the manufacturer's instructions have been adhered to.

10. POWER SOURCE

This unit should be operated only from the type of power source indicated on the rating plate. If you are not sure of the type of power supply to your home, consult your appliance dealer or local power company. For units intended to operate from battery power, or other sources, refer to the respective pages on this Owner's Manual for their operating instructions.

11. GROUNDING OR POLARIZATION

This unit is equipped with a polarized alternating-current line plug (a plug having one blade wider than the other). This plug will fit into the power outlet only one way. This is a safety feature. If you are unable to insert the plug fully into the outlet, try reversing the plug. If the plug should still fail to fit, contact your electrician to replace your obsolete outlet. Instead of the polarized alternating-current line plug, your unit may be equipped with a 3-wire grounding-type plug (a plug having a third (grounding) pin). This plug will only fit into a grounding-type power outlet. This too, is a safety feature. If you are unable to insert the plug into the outlet, contact your electrician to replace your obsolete outlet.

Do not defeat the safety purpose of the grounding-type plug.

12. POWER-CORD PROTECTION

Power-supply cords should be routed so that they are not likely to be walked on or pinched by items placed upon or against them, paying particular attention to cords at plugs, convenience receptacles, and the point where they exit from the appliance.

PORTABLE CART WARNING
(symbol provided by RETAC)



S3126A

IMPORTANT SAFEGUARDS

(Continued)

13. LIGHTNING

To protect your unit from a lightning storm, or when it is left unattended and unused for long periods of time, unplug it from the wall outlet and disconnect the antenna or cable system. This will prevent damage to the unit due to lightning and power line surges.

14. POWER LINES

An outside antenna system should not be located in the vicinity of overhead power lines or other electric light or power circuits, or where it can fall onto or against such power lines or circuits. When installing an outside antenna system, extreme care should be taken to keep from touching such power lines or circuits, as contact with them might be fatal.

15. OVERLOADING

Do not overload wall outlets and extension cords, as this can result in a risk of fire or electric shock.

16. OBJECT AND LIQUID ENTRY

Do not push objects through any openings in this unit, as they may touch dangerous voltage points or short out parts that could result in fire or electric shock. Never spill or spray any type of liquid into the unit.

17. OUTDOOR ANTENNA GROUNDING

If an outside antenna or cable system is connected to the unit, be sure the antenna or cable system is grounded to provide some protection against voltage surges and built-up static charges, Section 810 of the National Electrical Code (NEC), ANSI/NFPA 70, provides information with respect to proper grounding of the mast and supporting structure, grounding of the lead-in wire to an antenna discharge unit, size of grounding conductors, location of antenna discharge unit, connection to grounding electrodes, and requirements for the grounding electrode.

18. SERVICING

Do not attempt to service this unit yourself as opening or removing covers may expose you to dangerous voltage or other hazards. Refer all servicing to qualified service personnel.

For example:

- a. When the power-supply cord or plug is damaged.
- b. If liquid has been spilled, or objects have fallen into the unit.
- c. If the unit has been exposed to rain or water.
- d. If the unit does not operate normally by following the operating instructions. Adjust only those controls that are covered by the operating instructions, as an improper adjustment of other controls may result in damage and will often require extensive work by a qualified technician to restore the unit to its normal operation.
- e. If the unit has been dropped or the cabinet has been damaged.
- f. When the unit exhibits a distinct change in performance, this indicates a need for service.

19. REPLACEMENT PARTS

When replacement parts are required, be sure the service technician uses replacement parts specified by the manufacturer or those that have the same characteristics as the original part.

Unauthorized substitutions may result in fire, electric shock or other hazards.

20. SAFETY CHECK

Upon completion of any service or repairs to this unit, ask the service technician to perform safety checks to determine that the unit is in proper operating condition.

21. HEAT

The product should be situated away from heat sources such as radiators, heat registers, stoves, or other products (including amplifiers) that produce heat.

22. DISC TRAY

Keep your fingers well clear of the disc tray as it is closing. It may cause serious personal injury.

23. CONNECTING

When you connect the product to other equipment, turn off the power and unplug all of the equipment from the wall outlet. Failure to do so may cause an electric shock and serious personal injury. Read the owner's manual of the other equipment carefully and follow the instructions when making any connections.

24. SOUND VOLUME

Reduce the volume to the minimum level before you turn on the product. Otherwise, sudden high volume sound may cause hearing or speaker damage.

25. SOUND DISTORTION

Do not allow the product output distorted sound for a longtime. It may cause speaker overheating and fire.

26. HEADPHONES

When you use the headphones, keep the volume at a moderate level. If you use the headphones continuously with high volume sound, it may cause hearing damage.

27. LASER BEAM

Do not look into the opening of the disc tray or ventilation opening of the product to see the source of the laser beam. It may cause sight damage.

28. DISC

Do not use a cracked, deformed, or repaired disc. These discs are easily broken and may cause serious personal injury and product malfunction.

29. NOTE TO CABLE TV SYSTEM INSTALLER

This reminder is provided to call the Cable TV system installer's attention to Article 820-40 of the NEC that provides guidelines for proper grounding and, in particular, specifies that the cable ground shall be connected to the grounding system of the building, as close to the point of cable entry as practical.

EXAMPLE OF ANTENNA GROUNDING AS PER THE
NATIONAL ELECTRICAL CODE

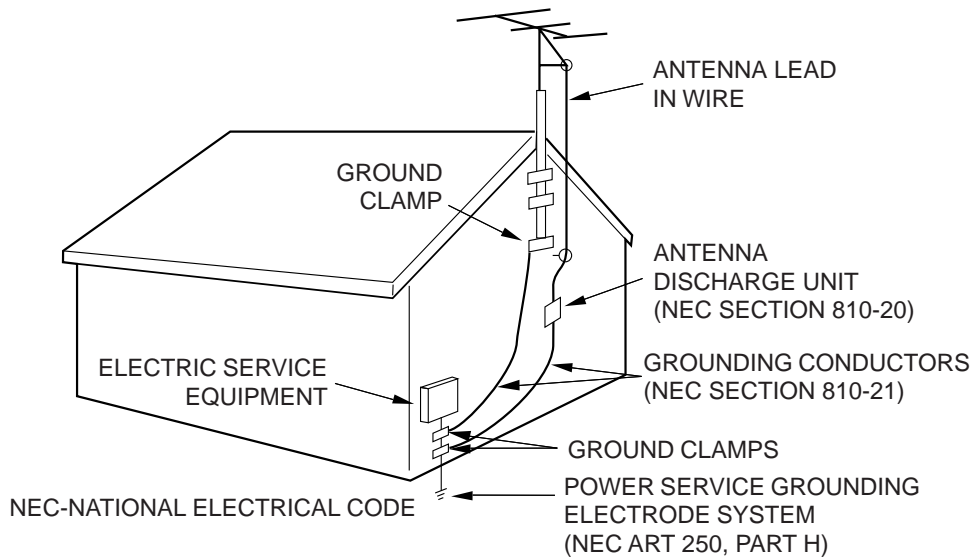

IMPORTANT RECYCLING INFORMATION

This product uses both Cathode Ray Tube (CRT) and other components that contain lead. In your community there might be regulations that require you to dispose these materials properly under environmental considerations. Please contact your local authorities, or the Electronic Industries Alliance (<http://www.eiae.org>) for disposal or recycling information.

Power source

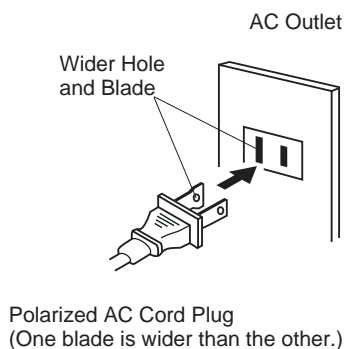

TO USE AC POWER SOURCE

Use the AC polarized line cord provided for operation on AC. Insert the AC cord plug into a standard 120V 60Hz polarized AC outlet.

Notes:

- Never connect the AC line cord plug to other than the specified voltage (120V 60Hz). Use the attached power cord only.
- If the polarized AC cord does not fit into a non-polarized AC outlet, do not attempt to file or cut the blade. It is the user's responsibility to have an electrician replace the obsolete outlet.
- If you cause a static discharge when touching the unit and the unit fails to function, simply unplug the unit from the AC outlet and plug it back in. The unit should return to normal operation.
- If the AC cord plug is plugged in for the first time, wait for approx. 5 seconds before pressing the POWER button.

Precautions

Notes on handling

- When shipping the unit, the original shipping carton and packing materials come in handy. For maximum protection, repack the unit as it was originally packed at the factory.
- Do not use volatile liquids, such as insect spray, near the unit. Do not leave rubber or plastic products to contact the unit for prolonged period. They will leave marks on the finish.
- The top and rear panels of the unit may become warm after a long period of use. This is not a malfunction.
- When the unit is not in use, be sure to remove the disc and turn off the power.
- If you do not use the unit for a long period, the unit may not function properly in the future. Turn on and use the unit occasionally.

Notes on locating

- Place the unit on a level surface. Do not use it on a shaky or unstable surface such as a wobbling table or inclined stand. The loaded disc may become disaligned and damage the unit.
- When you place this unit near a TV, radio, or VCR, the playback picture may become poor and the sound may be distorted. In this case, place the unit away from the TV, radio, or VCR.

Notes on cleaning

Use a soft, dry cloth for cleaning.

- For stubborn dirt, soak the cloth in a weak detergent solution, wring well and wipe. Use a dry cloth to wipe it dry.
Do not use any type of solvent, such as thinner and benzene, as they may damage the surface of the unit.
- If you use a chemical saturated cloth to clean the unit, follow that product's instructions.

To obtain a clear picture

The unit is a high technology, precision device. If the optical pick-up lens and disc drive parts are dirty or worn down, the picture quality will deteriorate. To obtain a clear picture, we recommend regular inspection and maintenance (cleaning or parts replacement) every 1,000 hours of use depending on the operating environment. For details, contact your nearest dealer.

Notes on moisture condensation

Moisture condensation damages the unit. Please read the following carefully.

Moisture condensation occurs, for example, when you pour a cold drink into a glass on a warm day. Drops of water form on the outside of the glass. In the same way, moisture may condense on the optical pick-up lens inside this unit, one of the most crucial internal parts of the unit.

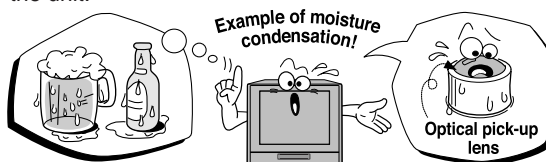

■ **Moisture condensation occurs during the following cases.**

- When you bring the unit directly from a cold place to a warm place.
- When you use the unit in a room where you just turned on the heater, or a place where the cold wind from the air conditioner directly hits the unit.
- In summer, when you use the unit in a hot and humid place just after you move the unit from an air conditioned room.
- When you use the unit in a humid place.

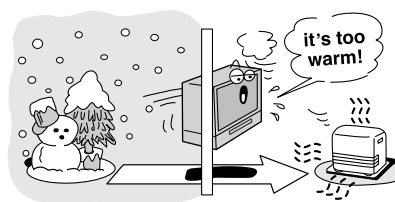

■ **Do not use the unit when moisture condensation may occur.**

If you use the unit in such a situation, it may damage discs and internal parts. Remove the disc, connect the power cord of the unit to the wall outlet, turn on the unit, and leave it for two or three hours. After two or three hours, the unit will have warmed up and evaporated any moisture. Keep the unit connected to the wall outlet and moisture condensation will seldom occur.

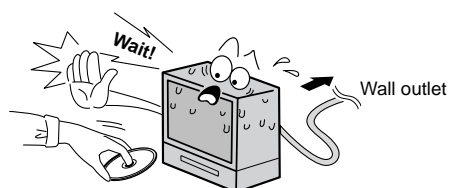

Notes on discs

On handling discs

- Do not touch the playback side of the disc.

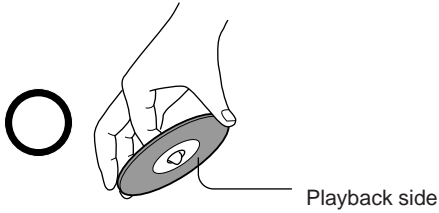

- Do not attach paper or tape to discs.



On cleaning discs

- Fingerprints and dust on the disc cause picture and sound deterioration. Wipe the disc from the center outwards with a soft cloth. Always keep the disc clean.

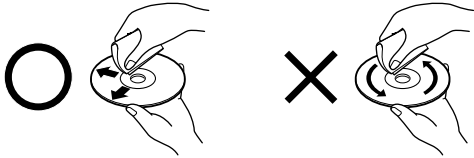

- If you cannot wipe off the dust with a soft cloth, wipe the disc lightly with a slightly moistened soft cloth and finish with a dry cloth.
- Do not use any type of solvent such as thinner, benzine, commercially available cleaners or antistatic spray for vinyl LPs. It may damage the disc.

On storing discs

- Do not store discs in a place subject to direct sunlight or near heat sources.
- Do not store discs in places subject to moisture and dust such as a bathroom or near a humidifier.
- Store discs vertically in a case. Stacking or placing objects on discs outside of their case may cause warping.

Structure of disc contents

Normally, DVD video discs are divided into titles, and the titles are sub-divided into chapters. Video CDs and Audio CDs are divided into tracks.

DVD video disc

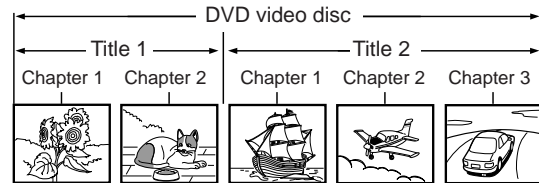

Video CD/Audio CD

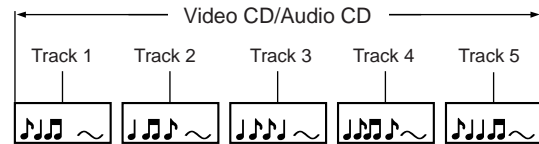

Each title, chapter or track is assigned a number, which is called "title number", "chapter number" or "track number" respectively.

There may be discs that do not have these numbers.

Notes on copyright

It is forbidden by law to copy, broadcast, show, broadcast on cable, play in public, and rent copyrighted material without permission.





DVD video discs are copy protected, and any recordings made from these discs will be distorted.

This product incorporates copyright protection technology that is protected by method claims of certain U.S. patents and other intellectual property rights owned by Macrovision Corporation and other rights owners. Use of this copyright protection technology must be authorized by Macrovision Corporation, and is intended for home and other limited viewing uses only unless otherwise authorized by Macrovision Corporation. Reverse engineering or disassembly is prohibited.



Notes on discs (Continued)

About this owner's manual

This owner's manual explains the basic instructions of this unit. Some DVD video discs are produced in a manner that allows specific or limited operation during playback. As such, the unit may not respond to all operating commands. This is not a defect in the unit. Refer to instruction notes of discs.

“” may appear on the TV screen during operation. A “” means that the operation is not permitted by the unit or the disc. For example, sometimes it is unable to stop the playback of copyright message of the disc when the STOP () button is pressed. Alternatively, the “” may also indicate that the feature is not available for the disc.

Notes on region numbers

The region number of this unit is 1. If region numbers, which stand for their playable area, are printed on your DVD video disc and you do not find  or , disc playback will not be allowed by the player. (In this case, the unit will display a message on-screen.)

On Video CDs

This DVD supports Video CDs equipped with the PBC (Version 2.0) function. (PBC is the abbreviation of Playback Control.) You can enjoy two playback variations depending on types of discs.

- **Video CD not equipped with PBC function (Version 1.1)**
Sound and movie can be played on this DVD in the same way as an audio CD.
- **Video CD equipped with PBC function (Version 2.0)**
In addition to operation of a Video CD not equipped with the PBC function, you can enjoy playback of interactive software with search function by using the menu displayed on the TV screen (Menu Playback). Some of the functions described in this owner's manual may not work with some discs.

Playable discs

This unit can play the following discs.

| | Disc Mark | Contents | Disc Size | Maximum playback time |
|-----------------|--|---------------------------------|------------------|---|
| DVD video discs |  | Audio + Video (moving pictures) | 12 cm | Approx. 4 hours (single sided disc) Approx. 8 hours (double sided disc) |
| | | | 8 cm | Approx. 80 minutes (single sided disc) Approx. 160 minutes (double sided disc) |
| Video CDs |  | Audio + Video (moving pictures) | 12 cm | Approx. 74 minutes |
| | | | 8 cm | Approx. 20 minutes |
| Audio CDs |  | Audio | 12 cm | Approx. 74 minutes |
| | | | 8 cm (CD single) | Approx. 20 minutes |

The following discs are also available.

- CD-R/CD-RW discs of CD-DA, Video CD or JPEG format
- Kodak Picture CD and FUJICOLOR CD format

Some of these discs may be incompatible.

- You cannot play discs other than those listed above.
- You cannot play discs of DVD-RAM, DVD-ROM, Photo CD, etc., or non standardized discs even if they may be labeled as above.
- Some CD-R/RWs can not be played back depending on the recording conditions.
- This unit uses the NTSC color system, and cannot play DVD video discs recorded in any other color system (PAL, SECAM, etc.).



Contents

Introduction

| | |
|----------------------------------|----|
| IMPORTANT SAFEGUARDS | 2 |
| Precautions | 6 |
| Notes on discs | 7 |
| Contents | 9 |
| Identification of controls | 10 |

Connections

| | |
|--|----|
| Antenna connections | 13 |
| Cable TV connections | 14 |
| Connecting to optional equipment | 15 |

Basic setup

| | |
|----------------------------|----|
| Starting setup | 18 |
| Setting the language | 19 |

TV operation

| | |
|---|----|
| TV operation | 20 |
| Closed captions | 22 |
| To memorize channels | 23 |
| Setting the V-Chip | 24 |
| Picture control adjustment | 26 |
| Adjusting the picture preference | 26 |
| Stereo and Second Audio Program (SAP) | 27 |

Basic playback

| | |
|----------------------|----|
| Playing a disc | 28 |
|----------------------|----|

Advanced playback

| | |
|------------------------------------|----|
| Zooming | 31 |
| Locating desired scene | 31 |
| Repeat playback | 32 |
| A-B Repeat playback | 32 |
| Program playback | 33 |
| Random playback | 33 |
| Changing angles | 34 |
| Title selection | 34 |
| DVD menu | 34 |
| Changing soundtrack language | 35 |
| Subtitles | 35 |
| Karaoke playback | 36 |
| Disc status | 36 |
| To turn off the PBC | 36 |
| JPEG playback | 37 |

Function setup

| | |
|--|----|
| Customizing the function settings | 38 |
| Temporary disabling of rating level by DVD disc | 41 |

Others

| | |
|------------------------------|----|
| Language code list | 42 |
| Reception disturbances | 43 |
| Troubleshooting | 44 |
| Specifications | 46 |
| Limited warranty | 47 |

Identification of controls

See the page in  for details.

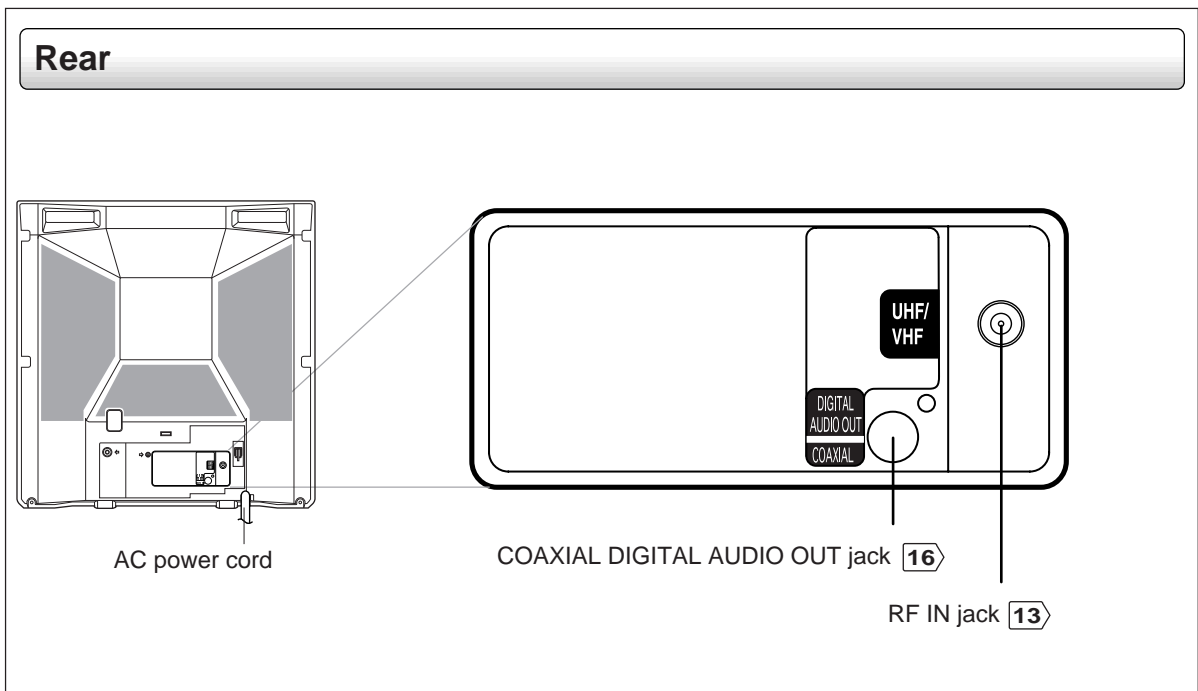
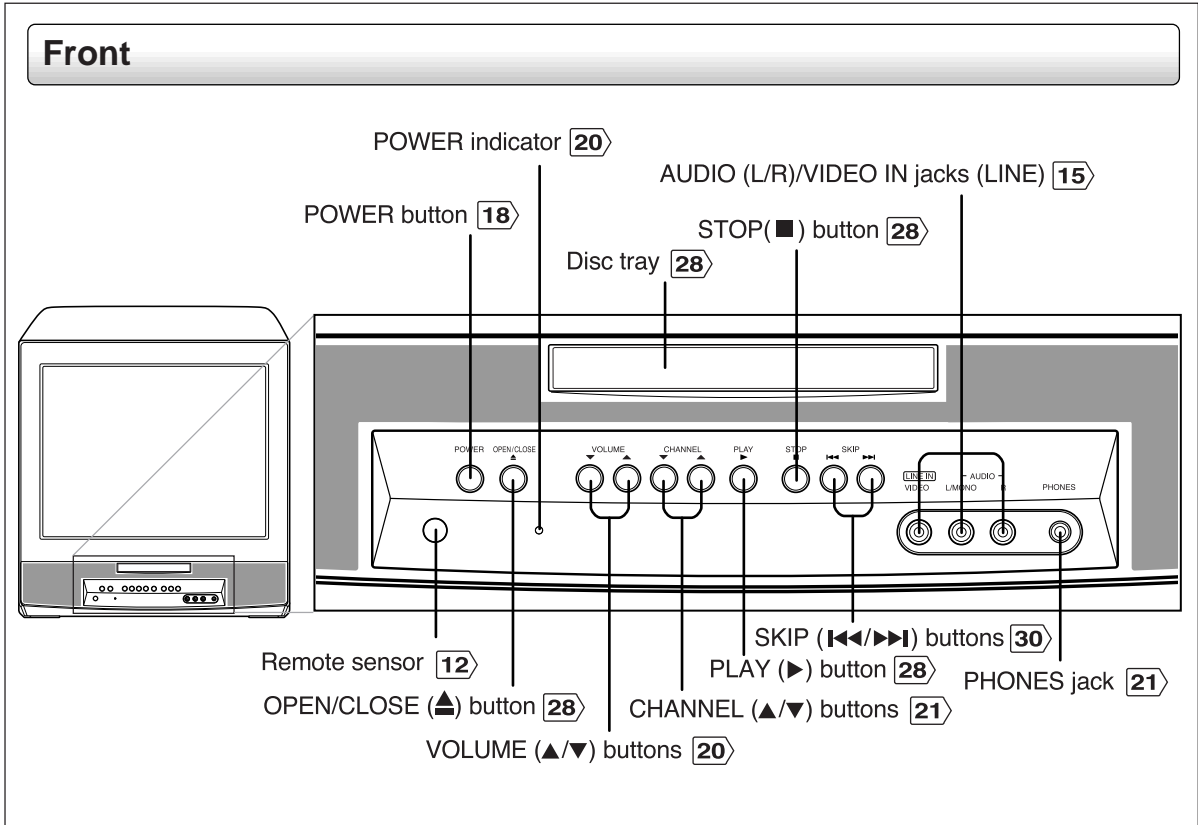

Remote control

The instructions in this manual describe the function on the remote control. See the page in  for details.

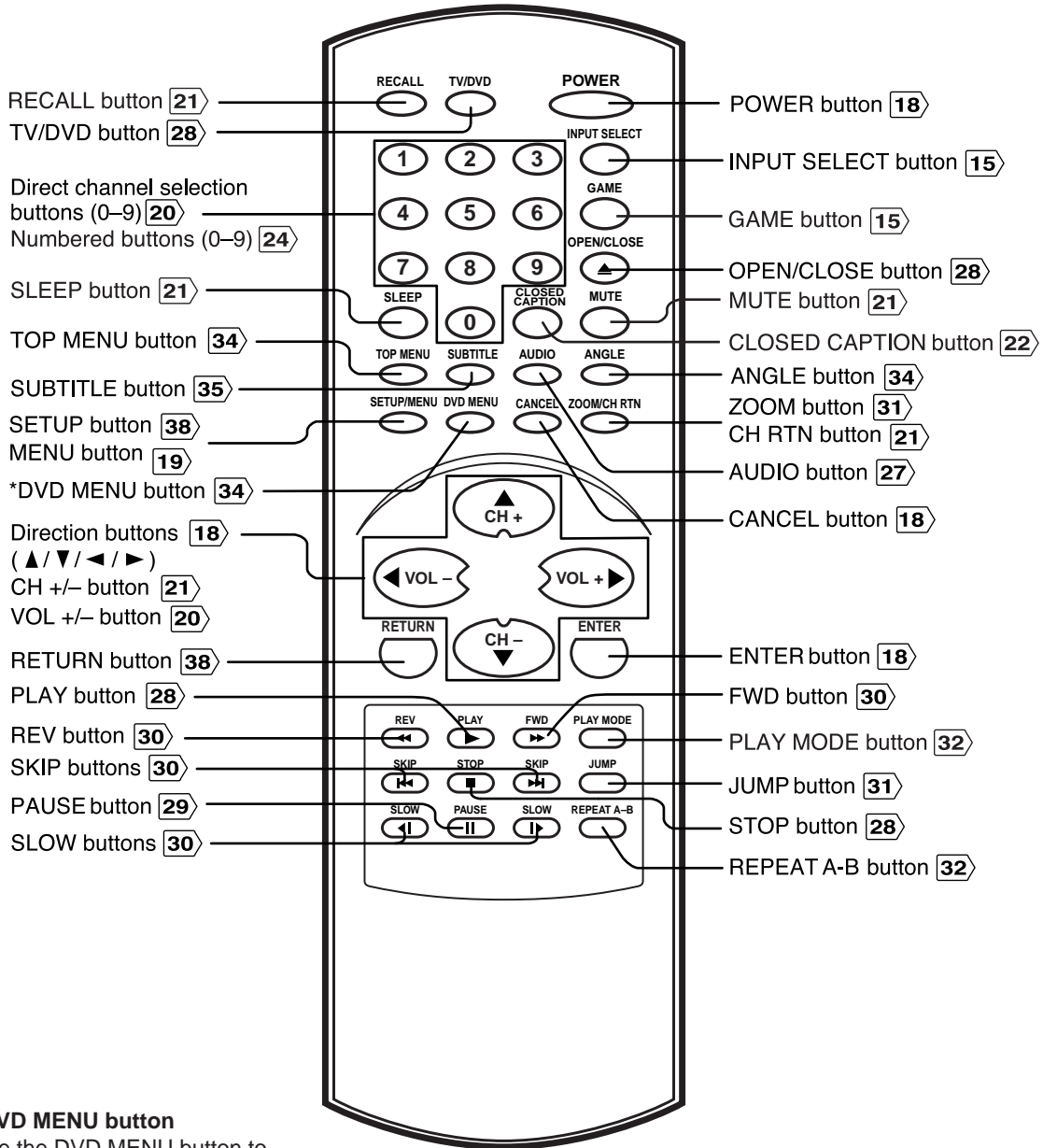

RECALL button **21**

TV/DVD button **28**

Direct channel selection

buttons (0–9) **20**

Numbered buttons (0–9) **24**

SLEEP button **21**

TOP MENU button **34**

SUBTITLE button **35**

SETUP button **38**

MENU button **19**

*DVD MENU button **34**

Direction buttons **18**

(▲/▼/◀/▶)

CH +/- button **21**

VOL +/- button **20**

RETURN button **38**

PLAY button **28**

REV button **30**

SKIP buttons **30**

PAUSE button **29**

SLOW buttons **30**

POWER button **18**

INPUT SELECT button **15**

GAME button **15**

OPEN/CLOSE button **28**

MUTE button **21**

CLOSED CAPTION button **22**

ANGLE button **34**

ZOOM button **31**

CH RTN button **21**

AUDIO button **27**

CANCEL button **18**

ENTER button **18**

FWD button **30**

PLAY MODE button **32**

JUMP button **31**

STOP button **28**

REPEAT A-B button **32**

*DVD MENU button

Use the DVD MENU button to display the menu included on many DVD video discs.

To operate a menu, follow the instructions in "DVD menu." **34**

Inserting batteries

- 1 Slide the battery compartment cover in the direction of the arrow.
- 2 Install two "R03/AAA" batteries (supplied), paying attention to the polarity diagram in the battery compartment.
- 3 Replace the compartment cover.

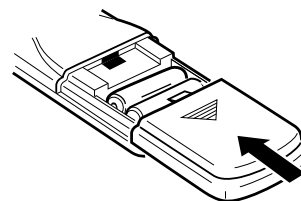
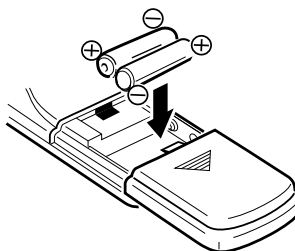
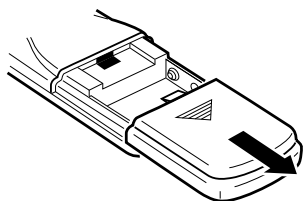

Operation

- Aim the remote control at the remote sensor and press control buttons to operate.
- Operate the remote control within 30° angle on either side of the remote sensor, up to a distance of approx. 5 meters.

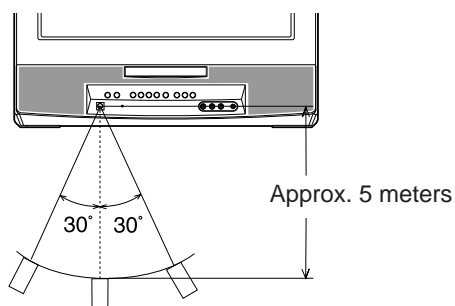

The precautions below should be followed when using batteries in this device:

1. Use only the size and type of batteries specified.
2. Be sure to follow the correct polarity when installing the batteries as indicated in the battery compartment. Reversed batteries may cause damage to the device.
3. Do not mix different types of batteries together (e.g. Alkaline and Carbon-zinc) or old batteries with fresh ones.
4. If the device is not to be used for a long period of time, remove the batteries to prevent damage or injury from possible battery leakage.
5. Do not try to recharge batteries not intended to be recharged; they can overheat and rupture (follow battery manufacturer's directions).

Antenna connections

If you are using an indoor or outdoor antenna, follow the instructions below that correspond to your antenna system. If you are using a cable TV service (CABLE), see page 14 for Cable TV connections.

Combination VHF/UHF antenna (Single 75 ohm cable or 300 ohm twin-lead wire)

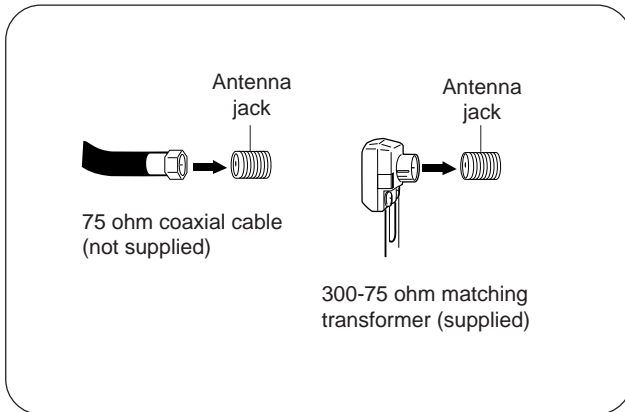

Connect the 75 ohm cable from the combination VHF/UHF antenna to the antenna jack.

If your combination VHF/UHF antenna has a 300 ohm twin-lead wire, the use of the 300-75 ohm matching transformer may be necessary.

Connections

Combination VHF/UHF antenna (Separate VHF and UHF 300 ohm twin-lead wires)

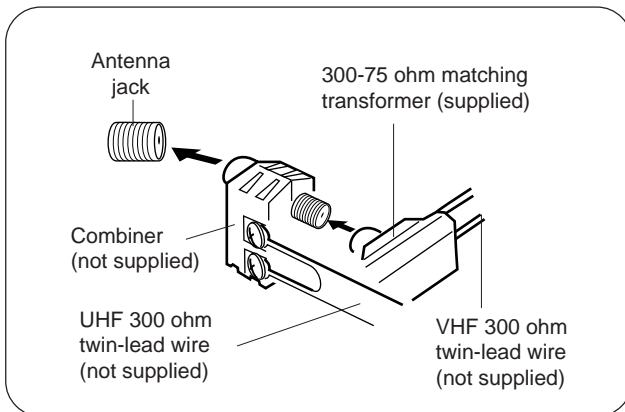

Connect the UHF 300 ohm twin-lead wire to the combiner (not supplied). Connect the VHF 300 ohm twin-lead wire to the 300-75 ohm matching transformer. Attach the transformer to the combiner, then attach the combiner to the antenna jack.

Separate VHF/UHF antennas (75 ohm VHF cable and 300 ohm UHF twin-lead wires)

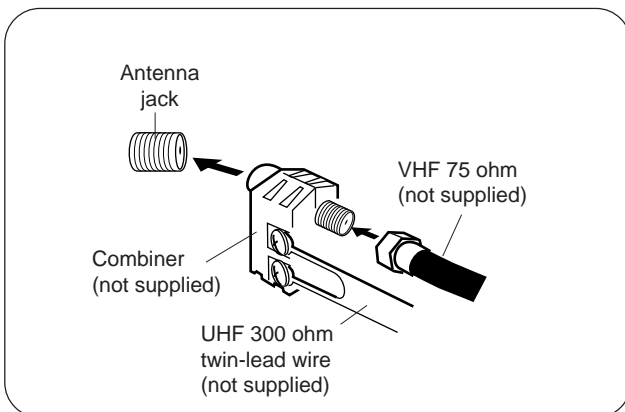

Connect the VHF 75 ohm cable and UHF 300 ohm twin-lead wire to the combiner (not supplied). Attach the combiner to the antenna jack.

Cable TV connections

This TV/DVD has an extended tuning range and can tune most cable channels without using a Cable TV converter box. Some cable companies offer "premium pay channels" in which the signal is scrambled. Descrambling these signals for normal viewing requires the use of a descrambler device which is generally provided by the cable company.

For subscribers to basic cable TV service

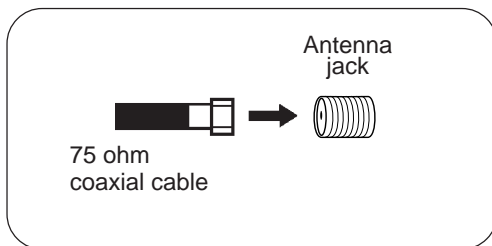

For basic cable service not requiring a converter/descrambler box, connect the Cable TV 75 ohm coaxial cable directly to the Antenna jack on the back of the TV/DVD.

For subscribers to scrambled cable TV service

If you subscribe to a cable TV service which requires the use of a converter/descrambler box, connect the incoming 75 ohm coaxial cable to the converter/descrambler box. Using another 75 ohm coaxial cable, connect the output jack of the converter/descrambler box to the antenna jack on the TV/DVD. Follow the connections shown below. Set the TV/DVD to the output channel of the converter/descrambler box (usually channel 3 or 4) and use the converter/descrambler box to select channels.

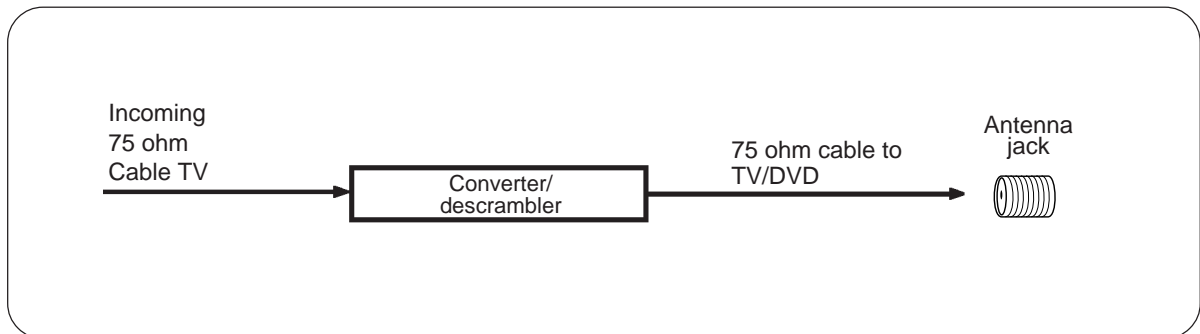

For subscribers to unscrambled basic cable TV service with scrambled premium channels

If you subscribe to a cable TV service in which basic channels are unscrambled and premium channels require the use of a converter/descrambler box, you may wish to use a signal splitter and an A/B Switch box (available from the cable company or an electronics supply store). Follow the connections shown below. With the switch in the "B" position, you can directly tune any unscrambled channels on your TV/DVD. With the switch in the "A" position, tune your TV/DVD to the output of the converter/descrambler box (usually channel 3 or 4) and use the converter/descrambler box to tune scrambled channels.

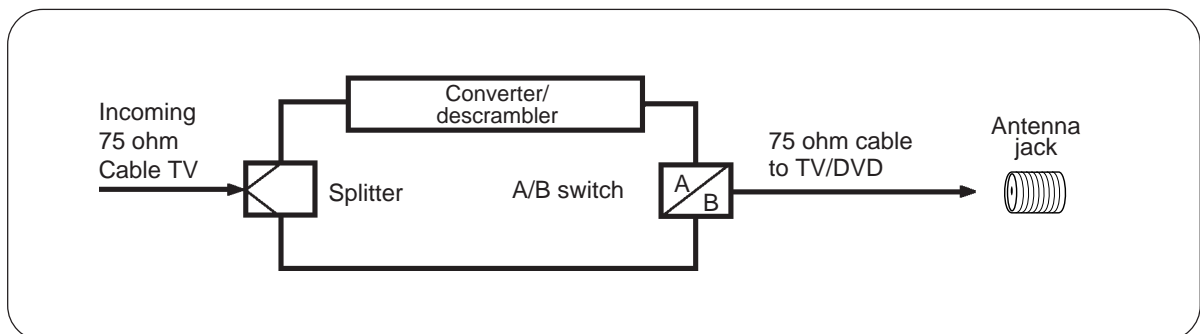



Connecting to optional equipment

You can enjoy VCR, camcorder or TV game with connection to external input. To select the external input, press **INPUT SELECT** and select "LINE" mode.

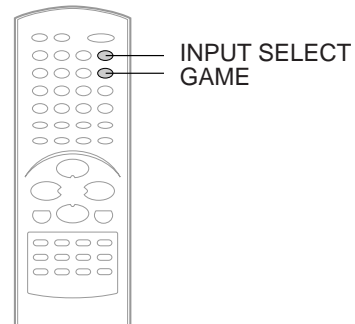

To connect the TV/DVD to a VCR

Press the **INPUT SELECT** to select the "LINE" (external input) to use the TV as a monitor. Operate your VCR as usual.

➡ : Signal flow

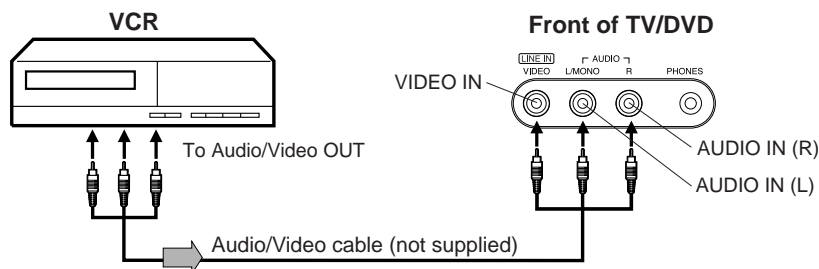

To connect the TV/DVD to a camcorder

To playback from the camcorder, connect the camcorder to the TV/DVD as shown.

➡ : Signal flow

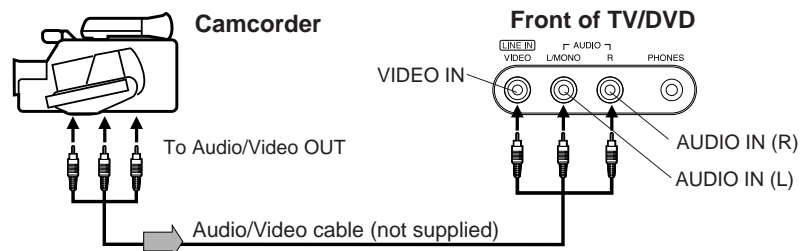

To connect the TV/DVD to a TV Game

You can enjoy playing a TV game on the screen by adjusting to suitable brightness for your eyes.

1. Connect a TV Game to the TV/DVD.
2. Press **GAME**. The GAME mode screen appears.
 - This TV/DVD has the GAME mode function (see page 21).

➡ : Signal flow

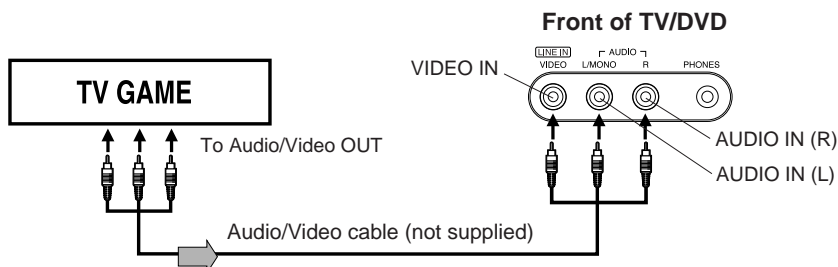

Notes:





- You can also change the TV screen to LINE by pressing the CH +/- buttons.
- The TV/DVD can also be used as a display device for many video games. However, due to the wide variety of different types of signal generated by these devices and subsequent hook-up variations required, they have not all been included in the suggested connection diagrams. You'll need to consult each component's Owner's Manual for additional information.



Connecting to optional equipment (Continued)

You can enjoy high quality dynamic sounds by connecting the TV/DVD to optional audio equipment.

* This section uses the following reference mark.

| | | | |
|---|-----------------|---|------------------|
|  | : Front speaker |  | : Center speaker |
|  | : Rear speaker |  | : Signal flow |
|  | : Sub woofer | | |

Connecting to an amplifier equipped with a Dolby Digital decoder

Dolby Digital

Dolby Digital is the surround sound technology used in theaters showing the latest movies, and is now available to reproduce this realistic effect in the home. You can enjoy motion picture and live concert DVD video discs with this dynamic realistic sound by connecting the TV/DVD to a 6 channel amplifier equipped with a Dolby Digital decoder or Dolby Digital processor. If you have a Dolby Surround Pro Logic decoder, you will obtain the full benefit of Pro Logic from the same DVD movies that provide full 5.1-channel Dolby Digital soundtracks, as well as from titles with the Dolby Surround mark.

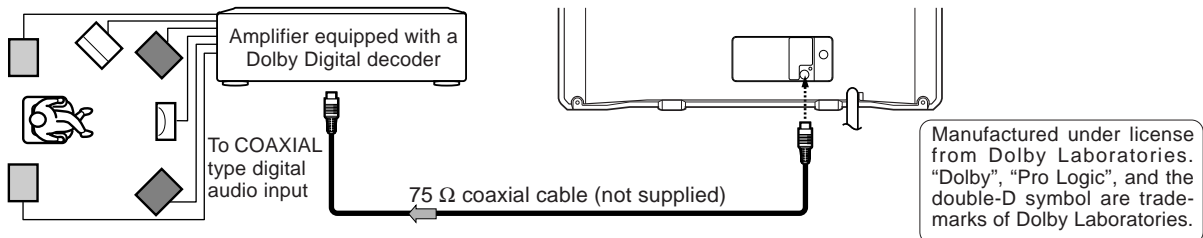

Connecting to an amplifier equipped with Dolby Surround Pro Logic

Dolby Surround Pro Logic

You can enjoy the dynamic realistic sound of Dolby Surround Pro Logic by connecting an amplifier and speaker system (right and left front speakers, a center speaker, and one or two rear speakers).

- With an amplifier equipped with Dolby Digital
Connect the equipment the same way as described in "Connecting to an amplifier equipped with a Dolby Digital decoder." Refer to that amplifier's owner's manual and set the amplifier so you can enjoy Dolby Surround Pro Logic sound.
- With an amplifier not equipped with Dolby Digital
Connect the equipment as follows.
 - This connection is only suitable for Video CDs and Audio CDs.

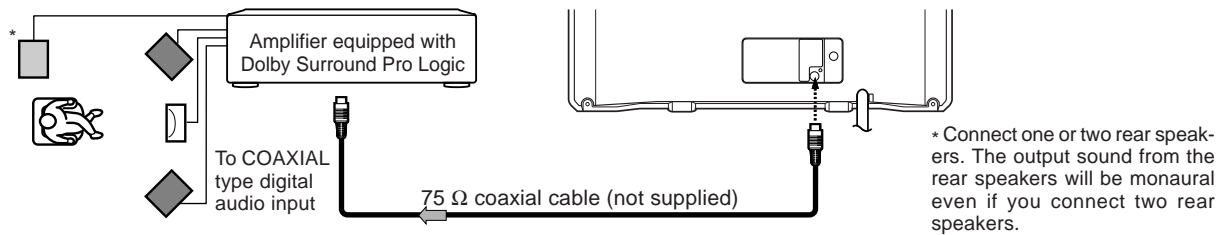

Connecting to an amplifier equipped with a DTS decoder

Digital Theater Systems (DTS)

DTS is a high quality surround technology used in theaters and now available for home use, on DVD video discs or audio CDs. If you have a DTS decoder or processor, you can obtain the full benefit of 5.1 channel DTS encoded sound tracks on DVD video discs or audio CDs.

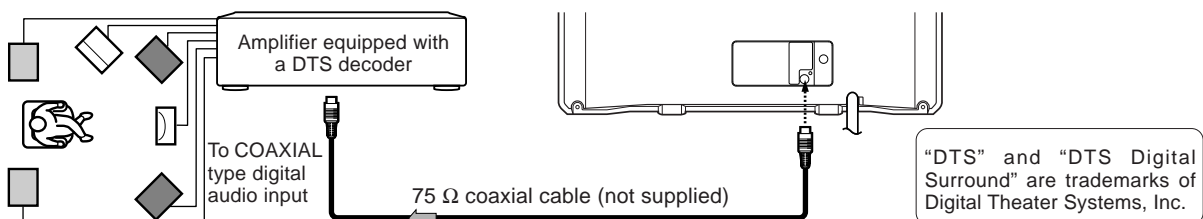



Connecting to an amplifier equipped with a MPEG audio decoder

MPEG2 sound

You can enjoy motion picture and live concert DVD video discs with dynamic realistic sound by connecting an amplifier equipped with an MPEG2 audio decoder or MPEG2 audio processor.

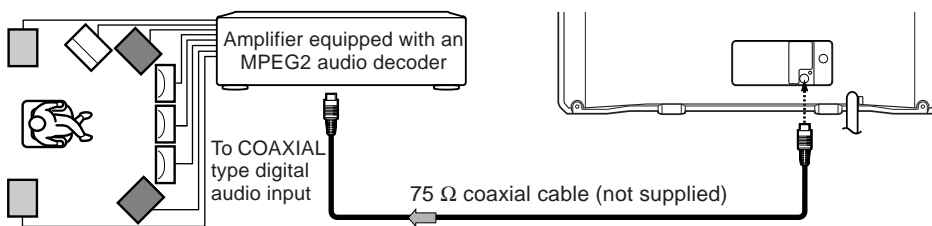

Connecting to an amplifier equipped with a digital audio input

2 channel digital stereo

You can enjoy the dynamic sound of 2 channel digital stereo by connecting an amplifier equipped with a digital audio input and speaker system (right and left front speakers).

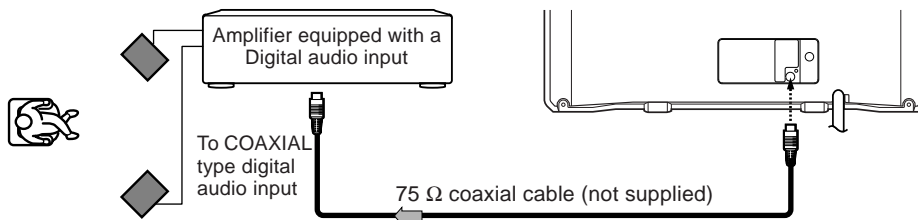

Notes:

- DO NOT connect the COAXIAL DIGITAL AUDIO OUT jack of the TV/DVD to the AC-3 RF input of a Dolby Digital Receiver. This input on your A/V Receiver is reserved for Laserdisc use only and is incompatible with the COAXIAL DIGITAL AUDIO OUT jack of the TV/DVD.
- Connect the COAXIAL DIGITAL AUDIO OUT jack of the TV/DVD to the "COAXIAL" input of a Receiver or Processor.
- Refer to the owner's manual of the connected equipment as well.
- When you connect the TV/DVD to other equipment, be sure to turn off the power and unplug all of the equipment from the wall outlet before making any connections.
- The output sound of the TV/DVD has a wide dynamic range. Be sure to adjust the receiver's volume to a moderate listening level. Otherwise, the speakers may be damaged by a sudden high volume sound.
- Turn off the amplifier before you connect or disconnect the TV/DVD's power cord. If you leave the amplifier power on, the speakers may be damaged.

Starting setup

The STARTING SETUP function makes installing your TV/DVD easily. It leads you the Language selection, TV/CABLE selection and auto channel memory automatically.

IMPORTANT: Make sure that the antenna or cable TV system connection is made!

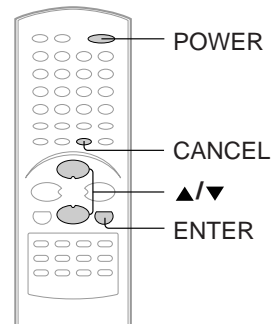

Starting setup

- 1** Press **POWER**. The starting setup function begins and the Language setup menu appears on the screen. Press **▲** or **▼** to select your desired language, then press **ENTER**.

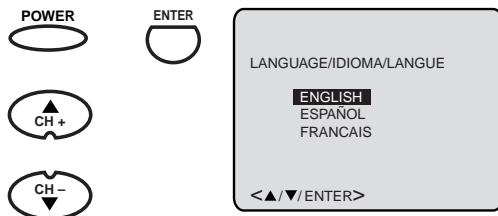

- 2** Press **▲** or **▼** to select "TV" or "CABLE", then press **ENTER**.

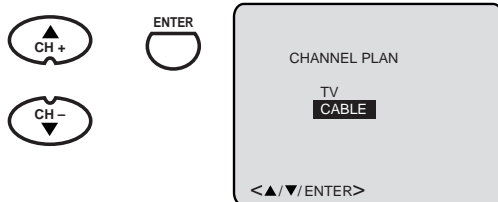

- 3** Press **▲** or **▼** to select "START", then press **ENTER**. If you select "CANCEL" and press **ENTER**, the STARTING SETUP stops and changes to the TV screen.

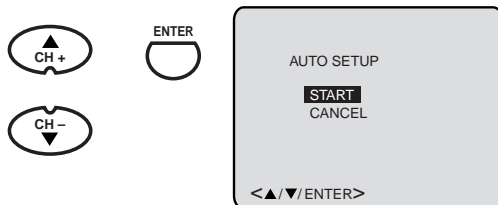

- 4** Now the "AUTO CH MEMORY" starts. After the starting setup is completed, the TV channel appears on the screen.

Note:

If you press the CANCEL button in the process of "AUTO CH MEMORY" you can do starting set up function again.



Note:

The starting setup function will work only when you press the POWER button for the first time.



Setting the language

This TV/DVD can display the on screen language in English, Spanish or French. Select the language you prefer first, then proceed with the other menu options.

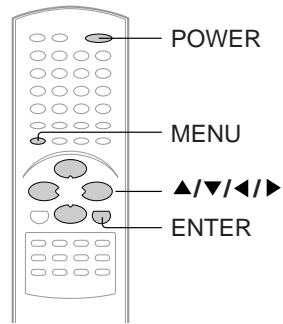

Setting the language

- 1** Press MENU, then press ◀ or ▶ to select option.

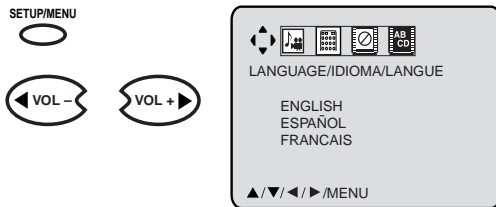

- 2** Press ▲ or ▼ to select the desired language: English (ENGLISH), Spanish (ESPAÑOL) or French (FRANCAIS), then press ENTER.

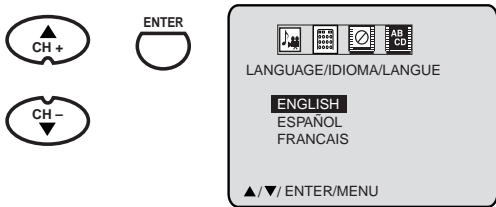

- 3** Press MENU repeatedly until the menu screen is cleared.



Notes:

- If the unit does not operate properly, or No key operation (by the unit and/or the remote control): Static electricity, etc., may affect the player's operation. Disconnect the AC power cord once, then connect it again.
- The TV section has its own menu and also DVD section has its own menu [38](#).

TV operation

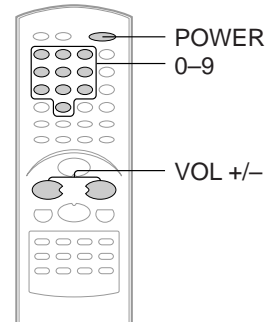

TV operation

1 To turn on the TV/DVD, press **POWER**. The Power indicator will light.



2 Adjust the volume level by pressing **VOL +** or **-**. The volume level will be indicated on the screen by green bars. As the volume level increases, so do the number of bars. If the volume decreases, the number of green bars also decreases.

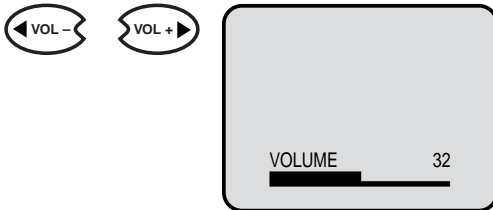

3 Set the TV/CABLE selection to the appropriate position. (See page 23.)

TV - VHF/UHF channels
CABLE - Cable TV channels

4 Press direct channel selection (**0-9**) to select the channel.

TV mode direct channel selection

When the TV/CABLE selection is in the TV position, all channels can be instantly selected by using two buttons. (for example, to select channel 2, press "0", then "2". If you press only "2", channel selection will be delayed for a few seconds.) For channels 10 and above, press the 2 digits in order.

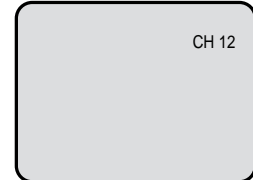

CABLE mode direct channel selection

When the TV/CABLE selection is in the CABLE position, channels can be selected as follows:
TO SELECT CABLE TV CHANNELS:

- 1-9: Press "0" twice, then 1-9 as needed. Example, to select channel 2, press "002".
- 10-12: Press "0", then the remaining 2 digits. Example, to select channel 12, press "012".
- 13-99: Press the 2 digits in order. Example, to select channel 36, press "36".
- 100-125: Press the 3 digits in order. Example, to select channel 120, press "120".

NOTE FOR CHANNELS 1-12:

If only 1 or 2 buttons are pressed, the corresponding channel will be selected in 2 seconds.

| TV | CATV |
|--------------|---|
| VHF 2-13 | VHF 2-13 |
| UHF 14-69 | STD/HRC/IRC 14-36 (A) (W) 37-59 (AA) (WW) 60-85 (AAA) (ZZZ) 86-94 (86) (94) 95-99 (A-5) (A-1) 100-125 (100) (125) 01 (5A) |

Notes:

- If a channel with no broadcast is selected, the sound will automatically be muted.
- If a station being viewed stops broadcasting, the TV will automatically shut itself off after 15 minutes.

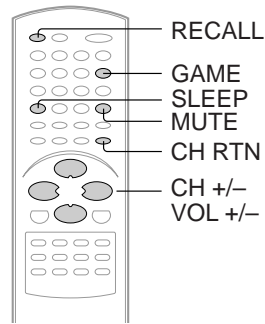

■ CHANNEL UP/DOWN

Press and release **CH +** or **-**. The channel automatically stops at the next channel set into memory. For proper operation, before selecting channels, they should be set into the memory. See page 23 "To memorize channels".

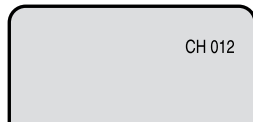
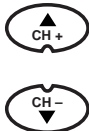

■ RECALL

Press **RECALL** to display the current informations on the screen. Press **RECALL** again to clear the display.

- Channel number or external input mode
- Stereo or SAP (Second Audio Program) audio status
- Audio output status

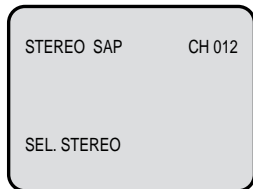

■ CH RETURN

This button allows you to go back to the last channel selected by pressing **CH RTN**. Press **CH RTN** again to return to the last channel you were watching.

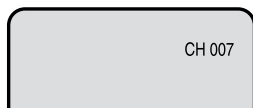

■ MUTE

Press **MUTE** to switch off the sound. The TV/DVD's sound will be silenced and "MUTE" will briefly appear on the screen. The sound can be switched back on by pressing this button again or one of **VOL + / -**.

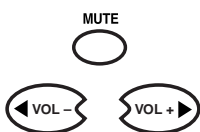

■ SLEEP

To set the TV/DVD to turn off after a preset amount of time, press **SLEEP** on the remote control. The clock will count down 10 minutes for each press of **SLEEP** (120, 110, ...10, 0). After the sleep time is programmed, the display will appear briefly every ten minutes to remind you that the sleep timer is operating. To confirm the sleep timer setting, press **SLEEP** and the remaining time will be displayed for a few seconds. To cancel the sleep timer, press **SLEEP** repeatedly until the display turns to 0.

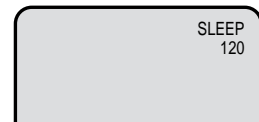

■ GAME MODE

After connecting a TV Game to the unit, press **GAME**. The TV screen changes to the Game mode.

- The Game mode screen is adjusted to the suitable brightness for your eyes.
- Game timer function: After one hour the Game timer display will appear every 30 minutes for approx. 5 seconds showing how long the time has passed up to 4 hours.
- If **GAME** is pressed during standby mode, the unit turns on automatically and the Game mode screen appears on the screen.

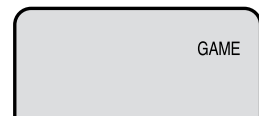

■ HEADPHONES

Insert a stereo headphones (not supplied) with a 1/8" mini plug into the PHONES jack on the front panel. If you connect headphones, the sound from TV speakers is muted.

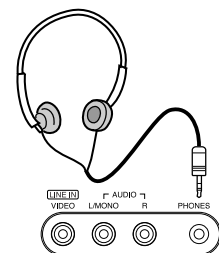

TV operation

Closed captions

WHAT IS CLOSED CAPTIONING?

This television has the capability to decode and display closed captioned television programs. Closed captioning will display text on the screen for hearing impaired viewers or it will translate and display text in another language.

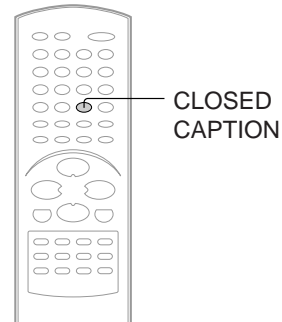

Closed captions

Captions: This closed caption mode will display text on the screen in English or another language (depending on the setting of the closed captions CH 1/2).

Generally, closed captions in English are transmitted on captions channel 1 and closed captions in other languages are transmitted on captions channel 2.

Text: The text closed caption mode will usually fill the screen with a programming schedule or other information. After selecting a closed caption mode, it will stay in effect until it is changed, even if the channel is changed. If the captions signal is lost due to a commercial or a break in the signal, the captions will reappear when the signal is received again. If the channels are changed, the captions will be delayed approximately 10 seconds. The captions will appear in places on the screen where they will least interfere with the picture, usually on the bottom of the screen. News programs will usually show three-line closed captions which scroll onto the screen. Most other shows provide two or three lined captions placed near the character who is speaking so the viewer can follow the dialogue. Words in italics or underlined describe titles, words in foreign languages or words requiring emphasis. Words that are sung usually appear enclosed by musical notes.

For television programs broadcasting with closed captions, look in your TV guide for the closed captions symbol (CC).

TO VIEW CLOSED CAPTIONS

Press **CLOSED CAPTION** to switch between normal TV and the two closed caption modes (captions and full screen text). Closed captioning will display text on the screen for hearing impaired viewers.

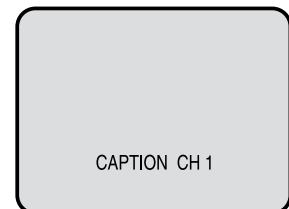

Notes:

- When selecting closed captions, the captioning will be delayed approximately 10 seconds.
- If no caption signal is received, no captions will appear, but the television will remain in the caption mode.
- Misspellings or unusual characters may occasionally appear during closed captioning. This is normal with closed captioning, especially with live programs. This is because during live programs, captions are also entered live. These transmissions do not allow time for editing.
- When captions are being displayed, on-screen displays, such as volume and mute may not be seen or may interfere with closed captions.
- Some cable systems and copy protection systems may interfere with the closed captioned signal.
- If using an indoor antenna or if TV reception is very poor, the closed caption decoder may not appear or may appear with strange characters or misspelled words. In this case, adjust the antenna for better reception or use an outdoor antenna.



To memorize channels

This TV/DVD is equipped with a channel memory feature which allows channels to skip up or down to the next channel set into memory, skipping over unwanted channels. Before selecting channels, they must be programmed into the TV/DVD's memory. In addition to normal VHF and UHF channels, this TV/DVD can receive up to 113 Cable TV channels. To use this TV/DVD with an antenna, set the TV/CABLE selection to the TV position. When shipped from the factory, this selection is in the CABLE position.

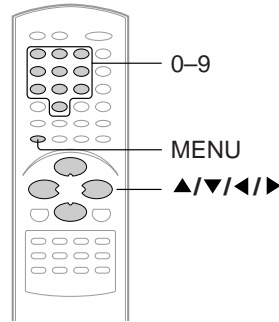

TV/CABLE selection

- 1 Press **MENU** in the TV mode, then press **◀** or **▶** to select option.

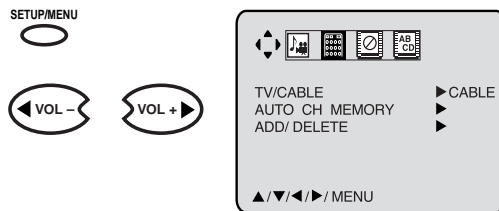

- 2 Press **▲** or **▼** to select "TV/CABLE".

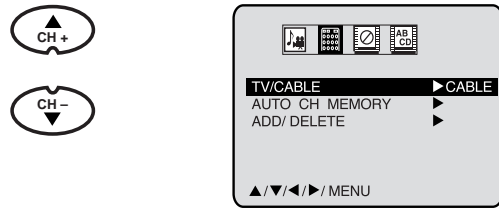

- 3 Press **◀** or **▶** to select "TV" or "CABLE".

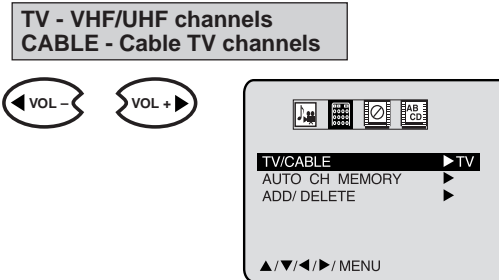

- 4 Press **MENU** repeatedly until the menu screen is cleared.



Cable TV chart

The chart below is typical of many cable system channel allocations.

| Number on this TV | Corresponding Cable TV channel | 14 | 15 | 16 | 17 | 18 | 19 | 20 | 21 | 22 |
|-------------------|--------------------------------|-----|-----|-----|-----|-----|-----|-----|-----|-----|
| A | B | C | D | E | F | G | H | I | | |
| 23 | 24 | 25 | 26 | 27 | 28 | 29 | 30 | 31 | 32 | 33 |
| J | K | L | M | N | O | P | Q | R | S | T |
| 41 | 42 | 43 | 44 | 45 | 46 | 47 | 48 | 49 | 50 | 51 |
| EE | FF | GG | HH | II | JJ | KK | LL | MM | NN | OO |
| 59 | 60 | 61 | 62 | 63 | 64 | 65 | 66 | 67 | 68 | 69 |
| WW | AAA | BBB | CCC | DDD | EEE | FFF | GGG | HHH | III | JJJ |
| 77 | 78 | 79 | 80 | 81 | 82 | 83 | 84 | 85 | 86 | 87 |
| RRR | SSS | TTT | UUU | VVV | WWW | XXX | YYY | ZZZ | 88 | 89 |
| 95 | 96 | 97 | 98 | 99 | 100 | 101 | 102 | 103 | 104 | 105 |
| A-5 | A-4 | A-3 | A-2 | A-1 | 100 | 101 | 102 | 103 | 104 | 105 |
| 113 | 114 | 115 | 116 | 117 | 118 | 119 | 120 | 121 | 122 | 123 |
| 113 | 114 | 115 | 116 | 117 | 118 | 119 | 120 | 121 | 122 | 123 |

Automatic memory tuning

- 1 Press **▲** or **▼** to select the "AUTO CH MEMORY", then press **▶**.
The TV will begin memorizing all the channels available in your area.

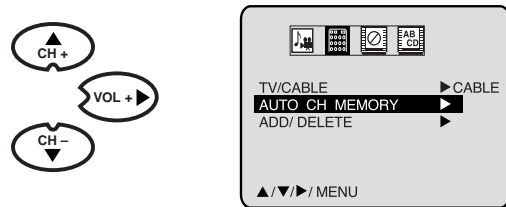

To ADD/DELETE channels

- 1 Press **▲** or **▼** to select "ADD/DELETE", then press **▶**.

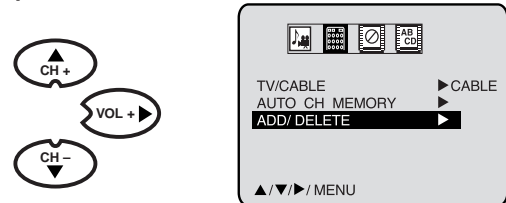

- 2 Select the desired channel to be added or deleted using Direct channel selection (0-9) or CH + / -.

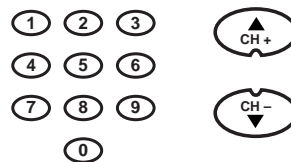

- 3 Press **◀** or **▶** to select "ADD" or "DELETE", whichever function you want to perform.

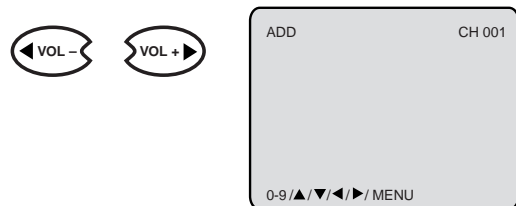

TV operation

Setting the V-Chip

An age limitation can be set to forbid children to watch programs according to "TV RATING" and "MOVIE RATING" level set. To use the V-Chip function, you must register a password.

Notes:

- If you forget the password, you cannot set the V-Chip.
- To avoid forgetting the password, write it down and keep in the safe place.

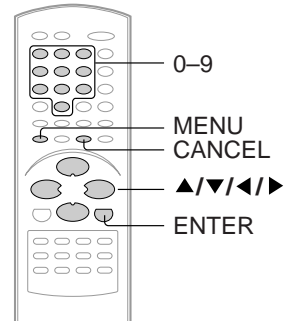

To register password

1 Press MENU, then press ◀ or ▶ to select option.

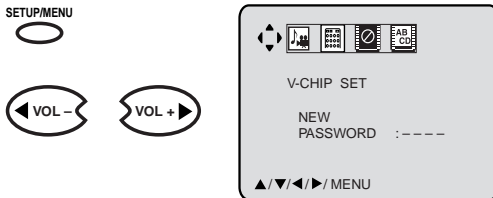

2 Press ▲ or ▼ to select "PASSWORD".

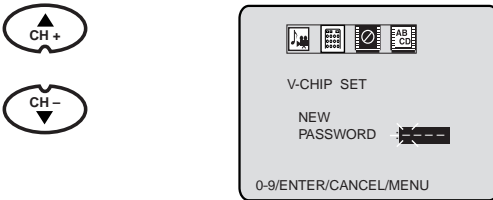

3 Enter the password (4 digits) using Number buttons (0-9), then press ENTER.

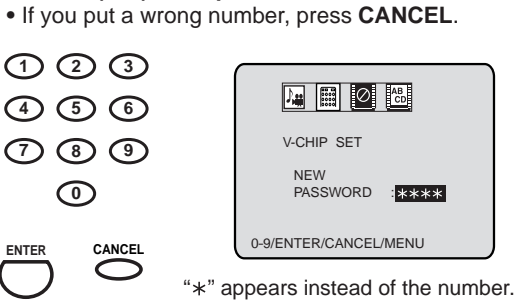

4 Enter the same password again for the safety, then press ENTER.

Now the password was registered and V-Chip setting menu will appear on the display.

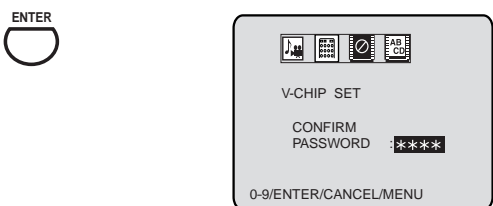

To change password

1 In the V-CHIP menu, press ▲ or ▼ to select "CHANGE PASSWORD", then press ▶.

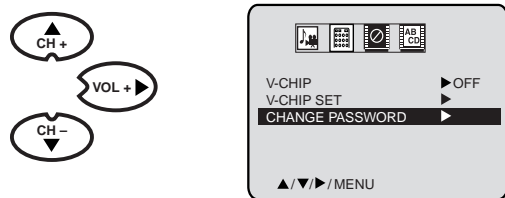

2 Enter the new password using Number buttons (0-9), then press ENTER.

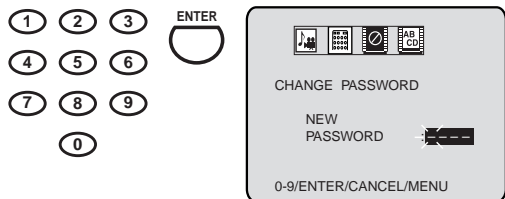

3 Enter the same password again using Number buttons (0-9) for safety, then press ENTER.

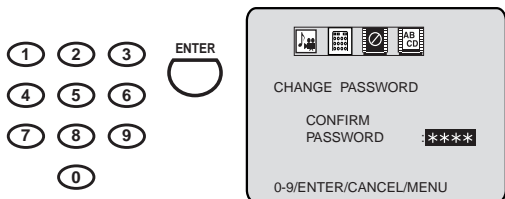

4 Press MENU repeatedly until the menu screen is cleared.



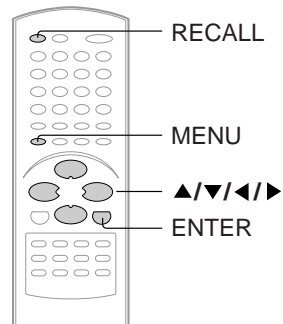

To set the V-Chip

1 In the V-CHIP menu, press ▲ or ▼ to select "V-CHIP SET", then press ▶.

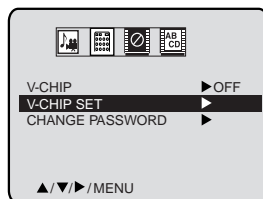
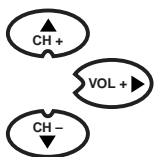

2 Press ▲ or ▼ to select "TV RATING", then press ◀ or ▶ to display the desired setting. After setting, press ENTER.

- OFF : TV RATING is not set
- TV-Y : All children
- TV-Y7 : 7 years old and above
- TV-G : General audience
- TV-PG : Parental guidance
- TV-14 : 14 years old and above
- TV-MA : 17 years old and above

When you select TV-Y7, TV-PG, TV-14 or TV-MA, press **RECALL** to show the contained rating. Press ▲/▼ or ◀/▶ to select the desired item you want.

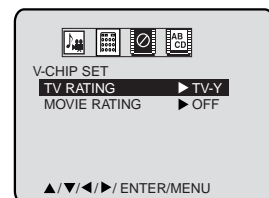
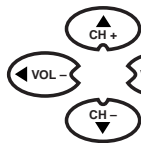

3 Press ▲ or ▼ to select "MOVIE RATING".

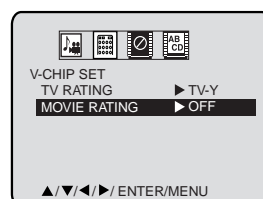
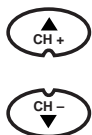

4 Press ◀ or ▶ to select desired rating. After setting, press ENTER.

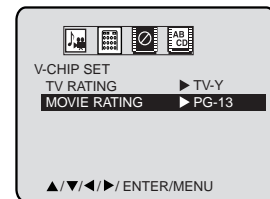
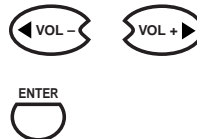

- OFF : MOVIE RATING is not set
- G : All ages
- PG : Parental guidance
- PG-13 : Parental guidance less than 13 years old
- R : Under 17 years old
- NC-17 : 17 years old and above
- X : Adult only

5 Press ▲ or ▼ to select "V-CHIP".

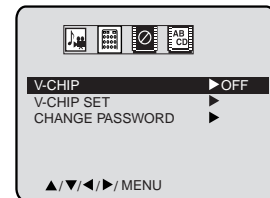
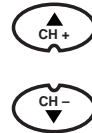

6 Press ◀ or ▶ to display "ON". Now your settings were set into the memory.

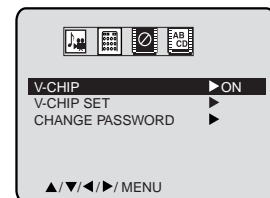

7 Press MENU repeatedly until the menu screen is cleared.



To use after the TV is protected

When the program applied to the V-Chip setting is received, enter the password, then press **ENTER**. Protection can be canceled.

Note:

The V-Chip function is activated only on programs that have the rating signal.

TV operation

Picture control adjustment / Adjusting the picture preference

Picture controls are factory preset but you can adjust them individually as follows:
And also you can select four picture modes—Standard, Sports, Movie, and Memory—as described in the following table:

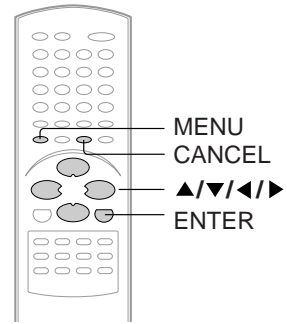

Picture control adjustment

1 Press MENU, then press ◀ or ▶ to select

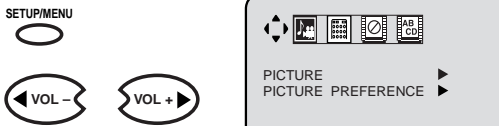

2 Press ▲ or ▼ to select "PICTURE", then press ▶.

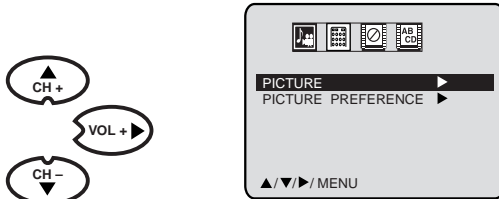

3 Press ▲ or ▼ to select the item you want to adjust, then press ◀ or ▶ to adjust the setting.

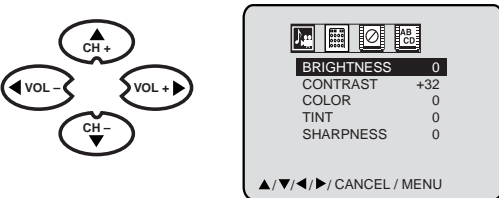

| Selection | ◀ Pressing ▶ | |
|------------|--------------|----------|
| BRIGHTNESS | darker | lighter |
| CONTRAST | lower | higher |
| COLOR | paler | deeper |
| TINT | reddish | greenish |
| SHARPNESS | softer | sharper |

Note:
The CONTRAST default setting is set to maximum (+32) at the factory.

4 After your desired setting press MENU repeatedly until the menu screen is cleared.



Adjusting the picture preference

1 Press MENU, then press ◀ or ▶ to select

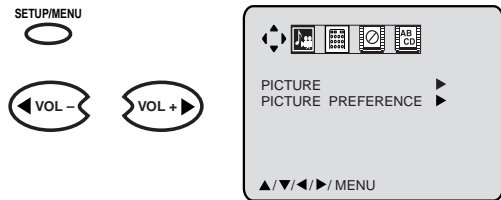

2 Press ▲ or ▼ to select "PICTURE PREFERENCE", then press ▶.

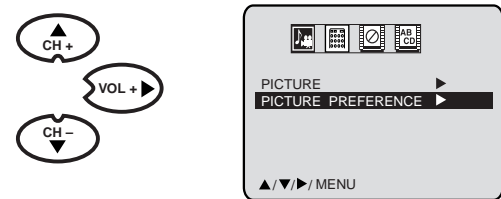

3 Press ▲ or ▼ to select the desired picture mode, then press ENTER.

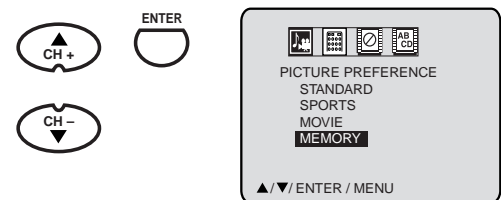

| Mode | Picture quality |
|----------|--|
| STANDARD | Standard picture quality (factory-set) |
| SPORTS | Bright and dynamic picture (factory-set) |
| MOVIE | Movie-like picture setting (factory-set) |
| MEMORY | Your personal preferences (set by you; see "Picture control adjustment" as left) |

4 After your desired setting press MENU repeatedly until the menu screen is cleared.



■ To return all adjustments to the factory preset levels
Press CANCEL while making picture adjustments.

Note:
You can not select "PICTURE PREFERENCE" in the Game mode.



Stereo and Second Audio Program (SAP)

The TV/DVD is equipped with a feature known as multi-channel TV sound or MTS. MTS broadcasts greatly enhance TV viewing by bringing you programs with high fidelity stereo sound.

MTS also provides an extra channel called the Second Audio Program or SAP which broadcasters can use to transmit a second language for bilingual transmission or for other purposes.

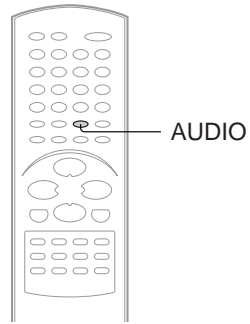

Listening to stereo sound

When the TV is turned on or a channel selection is made, make certain the "STEREO" appears on the screen. This means that Stereo broadcasting is available. You can enjoy stereo sound from the left and right speakers.

- When mono broadcasting is received, no indication is displayed.
- If the broadcast signal is not strong enough or clear stereo sound is not available, press **AUDIO** to change to mono sound. The noise should be eliminated. Press it again to return to the stereo sound.



Listening to SAP (Second Audio Program)

When the TV is turned on or a channel selection is made, make certain the SAP appears on the screen. This means that the Second Audio Program broadcasting is available.

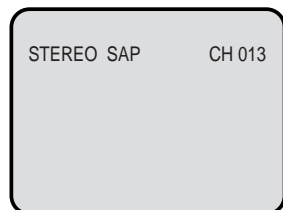

To select desired sound

Press **AUDIO** to select the desired sound.



MONO + SAP BROADCASTING

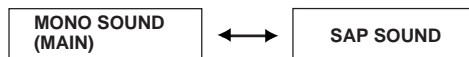

STEREO+SAP BROADCASTING

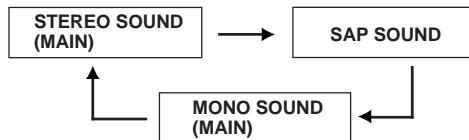

TV operation

Playing a disc

This section shows you the basics on how to play a disc.

CAUTION

Keep your fingers well clear of the disc tray as it is closing. Neglecting to do so may cause serious personal injury.

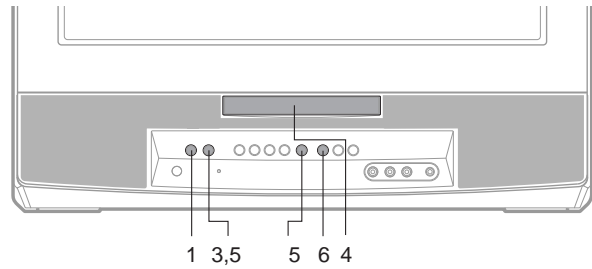

Basic playback

Preparations:

- Insert the AC cord plug into a standard 120V 60Hz polarized AC outlet. If the AC cord plug is plugged in for the first time, you need to set "Starting setup" [18].
- When connecting to other equipment, turn power off.

1 Press POWER on the unit or on the remote control to turn on the unit.
The Power indicator will light.

- Every time you press **POWER**, the TV/DVD starts from TV mode.
- When using an amplifier, switch on the amplifier.

2 Press TV/DVD to select DVD mode.
The DVD startup screen will appear on the screen. "Reading" display will change to "No Disc". (If DVD disc has already loaded, playback will start automatically.)

3 Press OPEN/CLOSE.
The disc tray opens.

4 Place the disc on the disc tray.

With the playback side down

- There are two different disc sizes. Place the disc in the correct guide on the disc tray. If the disc is out of the guide, it may damage the disc and cause the unit to malfunction.
- Do not place a disc which is unplayable on the disc tray.

5 Press OPEN/CLOSE or PLAY.

The disc tray closes automatically. On the TV-screen, "▲" changes to "Reading" and then playback commences.

- A menu screen will appear on the TV screen, if the disc has a menu feature. Press ▲/▼ or ◀/▶ to select title, then press **ENTER**. Title is selected and play commences.

6 Press STOP to end playback.

■ **Resuming facility**

- The unit records the stopped point, depending on the disc. "■" appears on the screen. Press **PLAY** to resume playback (from the scene point).
- If you press **STOP** again or unload the disc ("■" appears on the screen.), the unit will clear the stopped point.

■ **To start playback in the stop mode**
Press **PLAY**.



Note:
If the unit does not operate properly:
Static electricity, etc., may affect the player's operation. Disconnect the AC power cord once, then connect it again.



■ To obtain a higher quality picture

Occasionally, some picture noise not usually visible during a normal broadcast may appear on the TV screen while playing a DVD video disc because the high resolution pictures on these discs include a lot of information. While the amount of noise depends on the TV you use with this unit, you should generally reduce the sharpness adjustment on your TV when viewing DVD video discs.

■ About

The    icons on the heading bar show the playable discs for the function described under that heading.

 : You can use this function with DVD video discs.

 : You can use this function with Video CDs.

 : You can use this function with Audio CDs and CD-R/RW CDs.

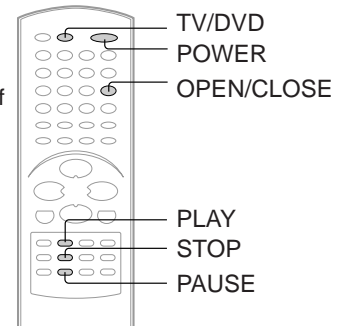

■ To pause playback (still mode)

Press **PAUSE** during playback.



To resume normal playback, press **PLAY**.

- The sound is muted during still mode.

■ To stop playback

Press **STOP**.



■ To remove the disc

Press **OPEN/CLOSE**.



Remove the disc after the disc tray opens completely.

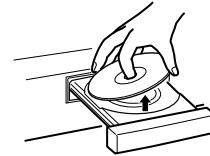

Be sure to press **OPEN/CLOSE** to close the disc tray after you remove the disc.

Basic playback

Notes:

- If a non-compatible disc is loaded, "Incorrect Disc", "Region Code Error" or "Parental Error" will appear on the TV screen according to the type of loaded disc. In this case, check your disc again (see pages 8 and 40).
- Some discs may take a minute or so to start playback.
- When you set a single-faced disc label downwards (ie. the wrong way up) and press the OPEN/CLOSE button or the PLAY button on the unit, "Reading" will appear on the display for 30 seconds and then "Incorrect Disc" will continue to be displayed.
- Some discs may not work the resuming facility.
- Resuming cannot function when you play a PBC-featured Video CD while the PBC is on. To turn off the PBC, see page 36.
- Some playback operations of DVDs may be intentionally fixed by software producers. Since this unit plays DVDs according to the disc contents the software producers designed, some playback features may not be available. Also refer to the instructions supplied with the DVDs.
- Do not move the unit during playback. Doing so may damage the disc.
- Use the OPEN/CLOSE button to open and close the disc tray. Do not push the disc tray while it is moving. Doing so may cause the unit to malfunction.
- Do not push up on the disc tray or put any objects other than discs on the disc tray. Doing so may cause the unit to malfunction.
- In many instances, a menu screen will appear after playback of a movie is completed. Prolonged display of an on-screen menu may damage your television set, permanently etching that image onto its screen. To avoid this, be sure to press the POWER button on your remote control once the movie is completed.
- There may be a slight delay between you pressing the button and the function activating.

Playing a disc (continued)

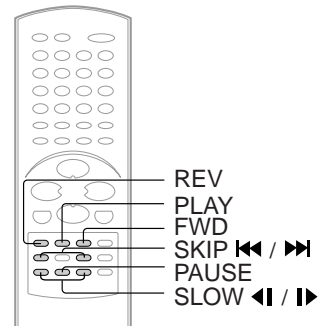

DVD VCD CD Playing in fast reverse or fast forward directions

Press REV or FWD during playback.



REV: Fast reverse playback
FWD: Fast forward playback

Each time you press **REW** or **FWD** button, the playback speed changes.

To resume normal playback

Press **PLAY**.



Notes:

- The TV/DVD mutes sound and subtitles during reverse and forward scan of DVD video discs. However, the TV/DVD plays sound during fast forward or fast reverse play of audio CDs.
- The playback speed may differ depending on the disc.

DVD VCD Playing frame by frame

Press PAUSE during still playback.



Each time you press **PAUSE**, the picture advances one frame.

To resume normal playback

Press **PLAY**.



Note:

The sound is muted during frame by frame playback.

DVD VCD Playing in slow-motion

Press **SLOW <|** (REVERSE) or **|>** (FORWARD) during playback.



Each time you press the button, the slow-motion speed changes.

To resume normal playback

Press **PLAY**.



Notes:

- The sound is muted during slow-motion playback.
- The Video CD can not play Reverse Slow.

DVD VCD CD Locating a chapter or track

Press **SKIP <<<** or **>>>** repeatedly to display the chapter or track number you want.

Playback starts from the selected chapter or track.



To locate succeeding chapters or tracks.



Playback starts from the beginning of the current chapter or track.
When you press twice in quick successions, playback starts from the beginning of the preceding chapter or track.

Notes:

- A "Prohibition" symbol may appear at the upper left of the screen. This symbol means either the feature you tried is not available on the disc, or the TV/DVD can not access the feature at this time. This does not indicate a problem with the TV/DVD.
- The unit is capable of holding a still video image or On screen display image on your television screen indefinitely. If you leave the still video image or On screen display image displayed on your TV for an extended period of time, you risk permanent damage to your television screen. Projection televisions are very susceptible.

Zooming/Locating desired scene

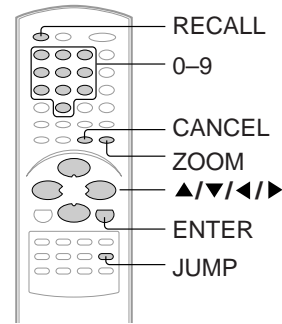

DVD VCD Zooming

This unit will allow you to zoom in on the frame image. You can then make selections by switching the position of the frame.

- 1 Press ZOOM during playback.**

ZOOM/CH RTN

The centre part of the image will be zoomed in. Each press of **ZOOM** will change the ZOOM Q1 (x 1.3), Q2 (x 1.5) and Q3 (x 2.0).
- 2 Press ▲/▼/◀/▶ to view a different part of the frame.**

You may move the frame from the center position to UP, DOWN, LEFT or RIGHT direction.
- 3 In the zoom mode press ZOOM repeatedly to return to a 1:1 view (Q Off).**

ZOOM/CH RTN

Notes:

- You can select the Pause, Slow or Search playback in the zoom mode.
- Some discs may not respond to zoom feature.

DVD VCD CD Locating desired scene

Use the title, chapter and time recorded on the disc to locate the desired point to playback. To check the title, chapter and time, press **RECALL**.

- 1 Press JUMP during playback or stop mode.**

JUMP
- 2 Press ▲ or ▼ to select the "Time", "Title" or "Chapter".**

CH+
CH-
- 3 Press Numbered buttons (0-9) to change the number.**

1 2 3
4 5 6
7 8 9
0

 - If you input a wrong number, press **CANCEL**.
 - Refer to the package supplied with the disc to check the numbers.
- 4 Press ENTER. Playback starts.**

ENTER

 - When you change the title, playback starts from Chapter 1 of the selected title.
 - Some discs may not work in the above operation.

Note:

In case of the Video-CD playback with PBC, the JUMP does not work. To turn off PBC, see page 36.

Advanced playback

Repeat playback/A-B Repeat playback

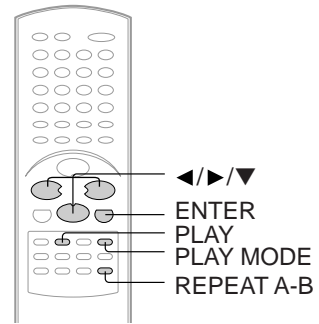

DVD VCD CD Repeat playback

- Press **PLAY MODE** during playback or stop mode.

PLAY MODE
- [DVD]**
Press **◀/▶** or **ENTER** once or twice to select "Chapter" or "Title".

[Audio CD, Video CD]
Press **▼** to select "Repeat".
Press **◀/▶** or **ENTER** once or twice to select "Track" or "All".

The unit automatically starts repeat playback after finishing the current title or chapter.

The unit automatically starts repeat playback after finishing the current track.

Repeat : Off
◀▶/Enter/Play Mode

Play Mode : Off
Repeat : Off
◀▶/Enter/Play Mode

 - If you set the repeat mode during stop mode, press **PLAY** to start Repeat playback.
- Press **PLAY MODE** again to make the screen disappear.

■ To resume normal playback

Select Repeat : "Off" in step 2.

Notes:

- Some discs may not work with the repeat operation.
- In case of Video CD with PBC, repeat functions are prohibited during playback.

DVD VCD CD A-B Repeat playback

A-B repeat playback allows you to repeat material between two selected points.

- Press **REPEAT A-B** during playback.

The start point is selected.

REPEAT A-B

A-
- Press **REPEAT A-B** again.

The end point is selected. Playback starts at the point that you selected. Playback stops at the end point, returns to Point A automatically, then starts again.

REPEAT A-B

A-B

■ To resume normal playback

Press **REPEAT A-B** again.

REPEAT A-B "Off" appears on the screen.

Notes:

- In A-B Repeat mode, subtitles near the A or B locations may not be displayed.
- You can not set the A-B Repeat for the scenes that include multiple angles.
- A-B Repeat playback does not work when Repeat playback is activated.
- You may not be able to set A-B Repeat, during certain scenes of the DVD.
- A-B Repeat does not work with an interactive DVD.
- A-B Repeat is prohibited when PBC is on.

Program playback/Random playback

You can arrange the playback order of tracks or files on the disc. And also the unit selects tracks or files at random and playback them. These feature works for Audio CD, Video CD and JPEG CD.

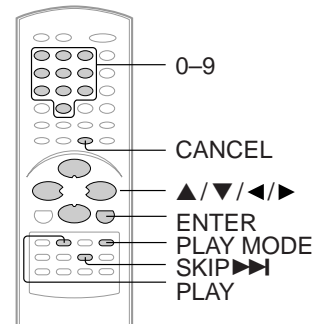

VCD CD Program playback

1 Press PLAY MODE in the stop mode.



Play Mode : Off
Repeat : Off
◀▲▼/Enter/Play Mode

2 Press ▲ or ▼ to select Play Mode, then press ◀/▶ or to select "Program".

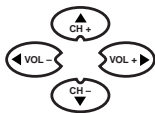

Play Mode : Program
Repeat : Off
1 --- 4 --- 7 --- 10 ---
2 --- 5 --- 8 --- 11 ---
3 --- 6 --- 9 --- 12 ---
[Clear] [Program Playback]
◀▲▼/Enter/0-9/Cancel/Play Mode

3 Press ▲/▼ or ◀/▶ to select the programming position. Use Number buttons (0-9) to input the Track or file numbers.

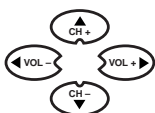

- To program others, repeat Step 3.
- If you input a wrong number, press **CANCEL**.

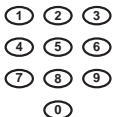

Play Mode : Program
Repeat : Off
1 9-- 4 --- 7 --- 10 ---
2 3-- 5 --- 8 --- 11 ---
3 11-- 6 --- 9 --- 12 ---
[Clear] [Program Playback]
◀▲▼/Enter/0-9/Cancel/Play Mode

4 Press ▲/▼/◀/▶ to select "Program Playback" and press ENTER.

The programs you selected will start to playback in the order.

- In case of JPEG file, press **SKIP ►►** to continue the program playback.
- To resume normal playback, select Play Mode: "Off" in step 2.

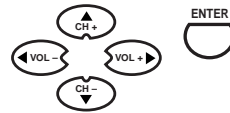

Play Mode : Program
Repeat : Off
1 9-- 4 --- 7 --- 10 ---
2 3-- 5 --- 8 --- 11 ---
3 11-- 6 --- 9 --- 12 ---
[Clear] [Program Playback]
◀▲▼/Enter/0-9/Cancel/Play Mode

To change the program

- In the program mode, press ▲/▼/◀/▶ to select the track number.
- Press **Number buttons (0-9)** to select the track number to be replaced.

To clear the program one by one

In the program mode, press ▲/▼/◀/▶ to select the track number. Then press **CANCEL**.

To clear all the programs

In the program mode, press ▲/▼/◀/▶ to select "Clear". Then press **ENTER**.

Notes:

- In playing back the Video CD with PBC, you can not set Program playback.
- The program is cancelled when you open the disc tray or turn the power off.

VCD CD Random playback

1 Press PLAY MODE during playback or stop mode.



2 Press ▲/▼ to select Play Mode, then press ◀/▶ or ENTER to select "Random".

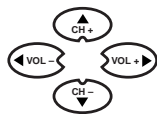

Play Mode : Random
Repeat : Off
◀▲▼/Enter/Play Mode

3 Press PLAY.



The Random Playback will start.

- If you set "Random" during playback mode, Random playback will begin after the track that is currently being played has ended.
- To resume normal playback, select Play Mode: "Off" in step 2.

Note:

In playing back the Video CD with PBC, you can not set Random playback.

Changing angles/Title selection/DVD menu

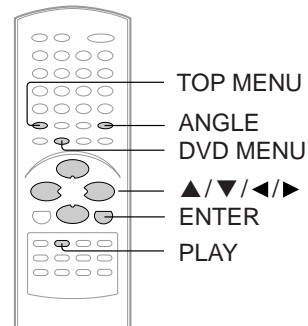

Changing angles

When playing back a disc recorded with multi-angle facility, you can change the angle that you are viewing the scene from.

1 Press ANGLE during playback.



The current angle will appear.

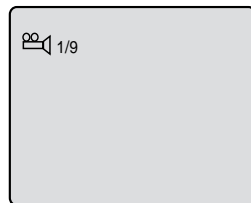

2 Press ANGLE repeatedly until the desired angle is selected.



Note:

Depending on the DVD, you may not be able to change the angles even if multi-angles are recorded on the DVD.

Title selection

Two or more titles are recorded on some discs. If the title menu is recorded on the disc, you can select the desired title.

1 Press TOP MENU during playback.



Title menu appears on the screen.

2 Press ▲/▼/◀/▶ to select the desired title.

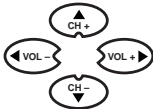

3 Press ENTER or PLAY.



The playback of the selected title will start.



Note:

Depending on the DVD, you may not be able to select the title. Depending on the DVD, a "title menu" may simply be called a "menu" or "title" in the instructions supplied with the disc.

DVD menu

Some DVDs allow you to select the disc contents using the menu.

When you play back these DVDs, you can select the subtitle language and sound-track language, etc. using the menu.

1 Press DVD MENU during playback.



The DVD menu appears on the screen.

- Press **DVD MENU** again to resume playback at the scene when you pressed **DVD MENU**.

2 Press ▲/▼/◀/▶ to select the desired item.

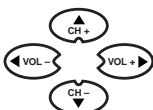

3 Press ENTER.



The menu continues to another screen. Repeat steps 2 and 3 to set the item completely.

Note:

Depending on the DVD, you may not be able to resume playback from the scene point when you pressed the DVD MENU button.



Changing soundtrack language/ Subtitles

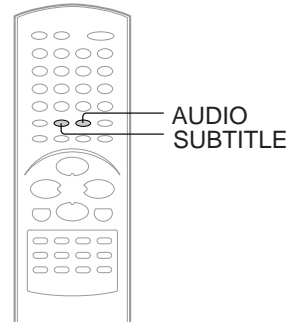

Changing soundtrack language

You can select the language when you play a multilingual disc.

1 Press **AUDIO** during playback.

The current soundtrack language will appear.

2 Press **AUDIO** repeatedly until the desired language is selected.

- The on screen display will disappear after a few seconds.

■ In case of Video CD playback

Audio type changes as follows each time you press **AUDIO**.

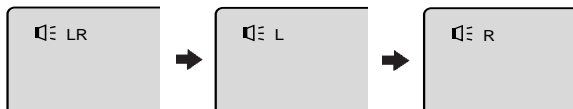

Notes:

- If the desired language is not heard after pressing the button several times, the language is not recorded on the disc.
- Changing soundtrack language is cancelled when you open the disc tray. The initial default language or available language will be heard if the disc is played back again.
- If you select DTS in playing DTS-encoded disc, no sound will be heard from the TV/DVD's speakers.

Subtitles

When playing back a disc recorded with subtitles, you can select the subtitle language or turn the subtitle off.

1 Press **SUBTITLE** repeatedly during playback until your desired language appears.

2 To turn off the subtitle, press **SUBTITLE** until "Off" appears.

- The on screen display will disappear after a few seconds.

Notes:

- Depending on the DVD, you may not be able to change subtitles, or to turn subtitles on or off.
- While playing a DVD, the subtitle may change when you open or close the disc tray.
- In some cases, a selected subtitle language may not be changed immediately.

Advanced playback

Karaoke playback/Disc status/ To turn off the PBC

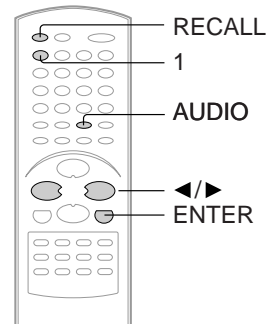

DVD Karaoke playback

You can turn the vocal on or off recorded on the DVD KARAOKE.

- 1 During DVD KARAOKE disc playback, press **AUDIO**.
The KARAOKE symbol (🎤) appears.

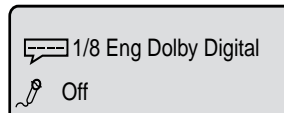

- If you play non-Karaoke disc, the KARAOKE symbol (🎤) does not appear.
- Some Karaoke discs may not have the vocal on/off function. In this case, the KARAOKE symbol (🎤) does not appear.

- 2 Press **◀** or **▶** to select "On" or "Off".

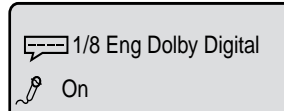

- On** : The primary vocal is output when it is recorded on the disc.
- Off** : The primary vocal is not output.
- The on screen display will disappear after a few seconds.

Notes:

- The vocal output feature is used during playback of Dolby Digital (multi-channel) recorded DVD KARAOKE discs. This feature allows you to turn off vocal audio tracks, or restore them for background accompaniment.
- When playing Karaoke, connect appropriate audio equipment such as an amplifier to the TV/DVD.

DVD VCD CD Disc status

With each press of **RECALL**, the status of the disc will appear on the screen and change as follows.



DVD

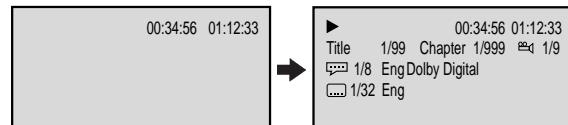

To make status display disappear, press **RECALL** again.

Video CD

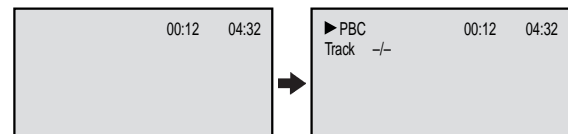

To make status display disappear, press **RECALL** again.

Audio CD

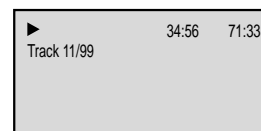

When you playback the CD disc, the status display will appear on the screen and continue displaying.

VCD To turn off the PBC

Press number button **1** in the stop mode, then press **ENTER**.





JPEG playback

You can select your desired JPEG file on the file menu and picture menu. The selected JPEG file is automatically adjusted to the TV screen. (When the aspect ratio of the JPEG file is different to your TV screen, the black bar will appear at the top and bottom, or the both sides of the TV screen.)

CAUTION:
Some JPEG CDs can not be played back depending on the recording conditions.

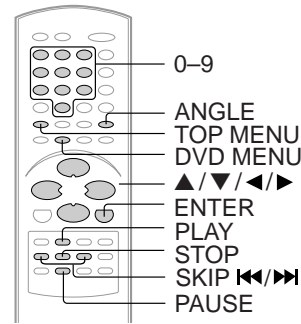

CD JPEG CD playback

- Place a disc on which JPEG files have been recorded onto the tray.
- A file menu screen will appear on the screen. Press **◀/▶** to select folder.
- Press **▲/▼/◀/▶** or Number buttons (0-9) to select the desired file. To display a picture menu, press **DVD MENU**. (To return to a file menu, press **TOP MENU**.) Press **◀/▶** or **▲/▼** to select the desired file.
 - To display next list, press **SKIP ◀/▶**.
- Press **ENTER**. The selected picture appears on the screen.

Rotating an image
You can rotate an image by 90 degrees by pressing **ANGLE** during playback of the image. "⏪", "⏩", "⏴", or "⏵" appears briefly on the screen.
- Press **STOP** to end playback. The file menu appears on the screen. If you want to watch the other file, repeat steps 3 ~ 4.

- Notes:**
- The picture menu is displayed when the FUJICOLOR CD or the Kodak Picture CD are played. To display the file menu, press **TOP MENU**.
 - During JPEG-Playback, you can not use SEARCH, A-B Repeat functions.
 - You can use Repeat (Track or All), Random functions and Program playback for JPEG CD playback. (See page 32.)

CD Slide show playback

The slide show enables you to view pictures (files) one after another automatically.

Preparation:
Set "JPEG Interval" setting to "5 Seconds", "10 Seconds" or "15 Seconds" (see page 39).

- Select your desired starting file for the slide show in the step 3 as left.
- Press **ENTER** to start slide show from the selected file.

- If you press **PAUSE** during the slide show, the slide show stops temporary. "⏪" appears briefly on the picture. If the picture appears upside down or sideways, press **ANGLE** repeatedly until it's right side up. "⏪", "⏩", "⏴", or "⏵" appears briefly on the screen. Press **PLAY** or **SKIP ▶▶** again to resume the slide show.
 - When the slide show playback finished the file list appears.
 - To stop the slide show, press **STOP**. The file list appears.

JPEG CD Information

Limitations on JPEG CD playback

- JPEG CD is the disc that is standardized by ISO9660, its file name must include 3-digits extension letters, ".jpg".
- The directory and file names of the JPEG CD must be correspond to the ISO standardized files.
- This unit can read 200 files per disc. If a disc has more than 200 files, it reads up to 200 files, the remaining files will be omitted.
- The unit is able to recognize up to a maximum of 50 directories per disc.
- It may take more than one minute for this unit to read JPEG files depending on its structure.

Limitations on display

- The maximum number for display is 16 letters. Available letters for display are the following: capital or small alphabets of A through Z, numbers of 0 through 9, and _ (under score).
- Other letters than those above are replaced in hyphen.

Notes on JPEG files

- To play back JPEG CD in the recorded order,
- Use JPEG software that records data alphabetically or numerically.
 - Name each file including two-digit or three-digit number (ex. "01" "02" or "001" "002").
 - Refrain from making too many sub-folders.

Advanced playback

Customizing the function settings

You can change the default settings to customize performance to your preference.

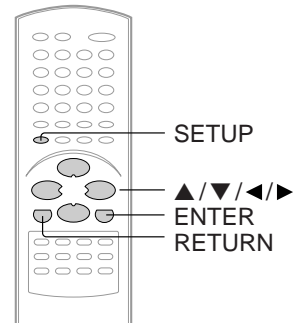

Setting procedure

1 Press SETUP during stop mode.



The following on-screen display appears.

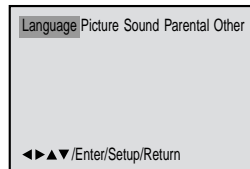

2 Press <Left> or <Right> to select the desired section, then press <Down> or ENTER.

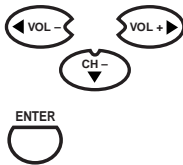

3 Press <Up> or <Down> to select the desired option.

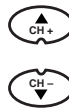

4 Change the selection using <Up>/<Down>/<Left>/<Right> or ENTER, by referring to the corresponding pages 39 and 40.

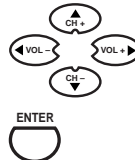

- Repeat step 3 and 4 to change other settings.
- Press <Up> to select another operation, go back to step 2.

5 To make SETUP screen disappear, press SETUP or RETURN.



| Section | Option | Details | Page |
|----------|---------------------------|--|------|
| Language | Menu Subtitle Audio | To select the language of "Menu", "Subtitle" and "Audio" if their languages are recorded onto the disc more than one language. | 39 |
| Picture | Tv Screen | To select a picture size according to the aspect ratio of your TV. | 39 |
| | Display | To turn on or de-activate the operational status display on the screen. | 39 |
| | JPEG Interval | To select a preferred setting for the slide show playback. | 39 |
| Sound | DRC | To select On or Off for DRC (Dynamic Range Control). | 40 |
| Parental | Password | Input 4-digit password to set the parental level. | 40 |
| | Parental | To select a preferred parental level for the parental setting. | |
| Other | OSD Language | To select a preferred language for on screen display. | 40 |



Setting details

Language

| Language | Picture | Sound | Parental | Other |
|----------|---------|-----------|----------|-------|
| Menu | | English | English | |
| Subtitle | | Automatic | Francais | |
| Audio | | English | Espanol | Other |

◀▶▲▼/Enter/Setup/Return

■ Menu, Subtitle, Audio

You can select the language of "Menu", "Subtitle" and "Audio" if more than one languages are recorded onto the disc.

English, Francais, Espanol:

The selected language will be heard or seen.

Other:

Other language can be selected (see the "Language code list" on page 42).

Original: (Audio)

The unit will select the first priority language of each disc.

Automatic: (Subtitle)

- The unit will automatically select the same language in the AUDIO setting.
- When the unit selects the same language as the AUDIO, the subtitles will not appear during playback.
- When you do not use the same language as the AUDIO, the subtitles will appear during playback.

Off: (Subtitle)

Subtitles do not appear.

Note:

If the selected language is not recorded on the disc, the first-priority language is selected.

Picture

| Language | Picture | Sound | Parental | Other |
|---------------|---|---|----------|-------|
| Tv Screen | 4:3 <input checked="" type="checkbox"/> | 4:3 <input checked="" type="checkbox"/> | | |
| Display | On | 4:3 <input type="checkbox"/> | | |
| JPEG Interval | Off | 16:9 <input type="checkbox"/> | | |

◀▶▲▼/Enter/Setup/Return

■ Tv Screen

You have the following screen sizes to choose from:

4:3 Letter box:

Select this mode when connecting to a conventional TV. When playing back a wide screen-DVD disc, it displays the wide picture with black bands at the top and bottom of screen.

4:3 Pan scan:

It displays the wide picture on the whole screen with left and right edges automatically cut off.

16:9 Wide:

Select this mode when connecting to a wide-screen TV. A wide screen picture is displayed full size.

Note:

If the DVD disc is not formatted in the pan & scan style, it displays 4:3 style.

■ Display

On screen display can be switched on or off when you press the buttons.

On: On screen displays appear when you press the buttons (factory setting).

Off: On screen displays do not appear when you press any buttons.

■ JPEG Interval

You can continuously play back all JPEG files automatically.

After the setting below, start playing the disc on which JPEG files have been recorded.

Off:

Plays back one file at a time.

5 Seconds:

Plays back images in the form of a slide show at 5 second intervals.

10 Seconds:

Plays back images in the form of a slide show at 10 second intervals.

15 Seconds:

Plays back images in the form of a slide show in 15 second intervals.



Function setup



Customizing the Function Settings (continued)

Setting details

Sound

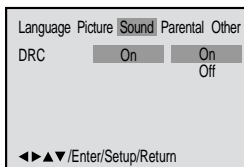

■ DRC

DRC (Dynamic Range Control) enables you to control the dynamic range so as to achieve a suitable sound for your equipment.

On: Loud sound such as explosion or similar is toned down slightly when played back. This makes it suitable for when it is connected to a stereo.

Off: It plays back at the recording level on the disc.

Notes:

- This function works only during playback of Dolby Digital recorded discs.
- The level of Dynamic Range Reduction may differ depending on DVD video disc.

Parental

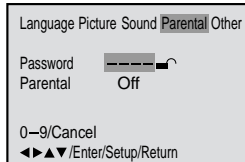

Parental control setting

Some discs are specified not suitable for children. Such discs can be limited not to play back with the unit.

- 1) Press **▲** or **▼** to select "Parental", then press **◀** or **▶** until the level you require appears.
 - Level Off: The parental control setting does not function.
 - Level 8: All DVD software can be played back.
 - Level 1: DVD software for adults cannot be played back.

Select from the level 1 to level 8. The limitation will be more severe as the level number is lower.

- 2) Press **▲** or **▼** to select "Password". Press **Number buttons (0-9)** to input a 4-digit password. Be sure to remember this number!
 - If you input a wrong number, press **CANCEL**.
- 3) Press **ENTER** to store the password.

Note: Now the rating is locked and the setting can not be changed unless you enter the correct password.

Notes:

- Depending on the discs, the unit cannot limit playback.
- Some discs may not be encoded with specific rating level information though its disc jacket says "adult." For those discs, the age restriction will not work.

To change the parental level

- 1) Press **▲** or **▼** to select "Password".
- 2) Press **Number buttons (0-9)** to enter the password you have stored.
- 3) Press **ENTER**.
 - The rating is now unlocked.
- 4) Press **▲** or **▼** to select "Parental", then press **◀** or **▶** to change the parental level.
- 5) Press **▲** or **▼** to select "Password", then press **Number buttons (0-9)** to enter the password.

Note: You can change the password if you want.
- 6) Press **ENTER**.

Now the parental level is changed and locked.

If you forget the password...

1. Press **OPEN/CLOSE** to open the disc tray.
2. Remove the disc.
3. Press **OPEN/CLOSE** again to close the disc tray. "No Disc" appears on the screen.
4. While holding **STOP** down on the front panel, press **7** on the remote control. "PASSWORD CLEAR" appears on the screen.
5. Enter a new password again.

Notes:

- Depending on the discs, the unit may not be able to limit playback.
- Some discs may not be encoded with specific rating level information though its disc jacket says "adult." For those discs, the parental control feature will not work.

Other

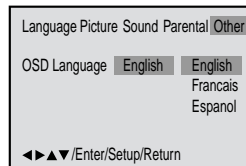

■ OSD Language

The setup language can be selected.

- English:** To display OSD language is English.
Francais: To display OSD language is Francais.
Espanol: To display OSD language is Espanol.

Note:

If each setup (pages 39 and 40) has been completed, the unit can always be worked under the same conditions (especially with DVD discs).

Each setup will be retained in the memory even if you turn the power off.

Temporary disabling of rating level by DVD disc

Depending on the DVD disc, the disc may try to temporarily cancel the rating level that you have set. It is up to you to decide whether to cancel the rating level or not.

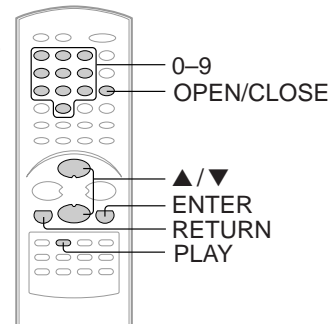

- 1** Load a DVD disc and press **PLAY** or **OPEN/CLOSE** on the unit **[28]**.

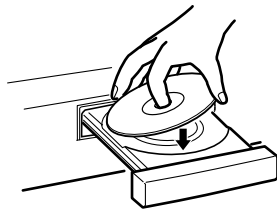

- 2** If the DVD disc has been designed to temporarily cancel the Rating level, the screen which follows the "Reading" screen will change, depending on which disc is played. If you select "YES" with the **ENTER** key, "Your disc exceeds the parental control level#." screen will then appear.



Your disc exceeds the parental control level#.
Parental Control Level
 Cancel Picture
 ▲▼/Enter/Return

- 3** If you wish to cancel the set rating level temporarily, select "Parental Control Level" with **▲** or **▼**, then press **ENTER**. If the 4-digit password at step 2 on page 40 has been set, the password entering screen will appear as shown in step 4. Alternatively, if the password has not been set, playback will commence. If you don't know (or have forgotten) the password, select "Cancel Picture". The setting screen will disappear. Press **OPEN/CLOSE** to remove the disc.



- 4** Enter the password with Number buttons (0-9). Then press **ENTER**.

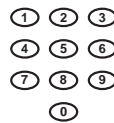

If you interrupt the entering, press **RETURN**.

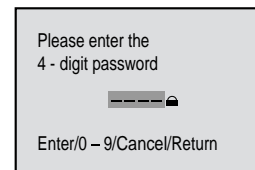

- 5** Playback will commence if the entered password was correct.

Note:

This temporary cancellation of rating level will be kept until the disc is ejected. When the disc is ejected, the original rating level will be set again automatically.

Function setup

Language code list

Enter the appropriate code number for the initial settings "Menu", "Subtitle" and/or "Audio" [39].

| Language Name | Code | Language Name | Code | Language Name | Code | Language Name | Code |
|-----------------|------|------------------|------|----------------|------|---------------|------|
| Abkhazian | 1112 | Fiji | 1620 | Lingala | 2224 | Singhalese | 2919 |
| Afar | 1111 | Finnish | 1619 | Lithuanian | 2230 | Slovak | 2921 |
| Afrikaans | 1116 | French | 1628 | Macedonian | 2321 | Slovenian | 2922 |
| Albanian | 2927 | Frisian | 1635 | Malagasy | 2317 | Somali | 2925 |
| Amharic | 1123 | Galician | 1722 | Malay | 2329 | Spanish | 1529 |
| Arabic | 1128 | Georgian | 2111 | Malayalam | 2322 | Sundanese | 2931 |
| Armenian | 1835 | German | 1415 | Maltese | 2330 | Swahili | 2933 |
| Assamese | 1129 | Greek | 1522 | Maori | 2319 | Swedish | 2932 |
| Aymara | 1135 | Greenlandic | 2122 | Marathi | 2328 | Tagalog | 3022 |
| Azerbaijani | 1136 | Guarani | 1724 | Moldavian | 2325 | Tajik | 3017 |
| Bashkir | 1211 | Gujarati | 1731 | Mongolian | 2324 | Tamil | 3011 |
| Basque | 1531 | Hausa | 1811 | Nauru | 2411 | Tatar | 3030 |
| Bengali; Bangla | 1224 | Hebrew | 1933 | Nepali | 2415 | Telugu | 3015 |
| Bhutani | 1436 | Hindi | 1819 | Norwegian | 2425 | Thai | 3018 |
| Bihari | 1218 | Hungarian | 1831 | Oriya | 2528 | Tibetan | 1225 |
| Breton | 1228 | Icelandic | 1929 | Panjabi | 2611 | Tigrinya | 3019 |
| Bulgarian | 1217 | Indonesian | 1924 | Pashto, Pushto | 2629 | Tonga | 3025 |
| Burmese | 2335 | Interlingua | 1911 | Persian | 1611 | Turkish | 3028 |
| Byelorussian | 1215 | Irish | 1711 | Polish | 2622 | Turkmen | 3021 |
| Cambodian | 2123 | Italian | 1930 | Portuguese | 2630 | Twi | 3033 |
| Catalan | 1311 | Japanese | 2011 | Quechua | 2731 | Ukrainian | 3121 |
| Chinese | 3618 | Javanese | 2033 | Rhaeto-Romance | 2823 | Urdu | 3128 |
| Corsican | 1325 | Kannada | 2124 | Romanian | 2825 | Uzbek | 3136 |
| Croatian | 1828 | Kashmiri | 2129 | Russian | 2831 | Vietnamese | 3219 |
| Czech | 1329 | Kazakh | 2121 | Samoan | 2923 | Volapük | 3225 |
| Danish | 1411 | Kirghiz | 2135 | Sanskrit | 2911 | Welsh | 1335 |
| Dutch | 2422 | Korean | 2125 | Scots Gaelic | 1714 | Wolof | 3325 |
| English | 1524 | Kurdish | 2131 | Serbian | 2928 | Xhosa | 3418 |
| Esperanto | 1525 | Laothian | 2225 | Serbo-Croatian | 2918 | Yiddish | 2019 |
| Estonian | 1530 | Latin | 2211 | Shona | 2924 | Yoruba | 3525 |
| Faroese | 1625 | Latvian, Lettish | 2232 | Sindhi | 2914 | Zulu | 3631 |



Reception disturbances

Most types of television interference can be remedied by adjusting the height and position of the VHF/UHF antenna. Outdoor antennas are recommended for best results. The most common types of television interference are shown below. If one of these symptoms appear when the TV/DVD is connected to a Cable TV system, the disturbance may be caused by the local Cable TV company broadcast.

IGNITION

Black spots or horizontal streaks may appear, the picture may flutter or drift. Usually caused by interference from automobile ignition systems, neon lamps or AC powered tools and appliances such as drills or hair dryers.



GHOSTS

Ghosts are caused by the television signal following two paths. One is the direct path and the other is reflected by tall buildings, hills or other large objects. Changing the direction or position of the antenna may improve the reception.



SNOW

If the TV/DVD is located far from the TV station, in a fringe reception area where the signal is weak, small dots may appear in the picture. If the signal is extremely weak, the installation of a larger external antenna may be necessary.



RADIO FREQUENCY INTERFERENCE (RFI)

Caused by two-way radios, this type of interference produces moving ripples or diagonal streaks in the picture. Some cases may cause a loss of contrast in the picture. Changing the direction and position of the antenna or installing an RFI filter may improve the picture.

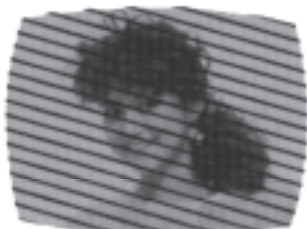

PICTURE SIZE VARIATION

A slight picture size variation is normal when you adjust the CONTRAST or BRIGHTNESS settings.



Others

CARE AND MAINTENANCE

To prevent fire or shock hazard, disconnect the TV/DVD from the power source before cleaning. The finish on the cabinet may be cleaned with mild soap and a soft, damp cloth and cared for as other furniture. Use caution when cleaning or wiping the plastic parts.

Troubleshooting

Use the following check list for troubleshooting when you have problems with your unit. Consult your local dealer or service outlet if problems persist.

Be sure all connections are properly made when using with other units.

| SYMPTOMS | POSSIBLE SOLUTIONS | PAGE |
|--|---|----------------------------|
| POWER | | |
| TV/DVD does not operate. | <ul style="list-style-type: none"> • Make sure the power cord is plugged in. • Try another AC outlet. • Power is off, check fuse or circuit breaker. • Unplug unit, then plug it back in. | 5 |
| TV BROADCAST RECEPTION | | |
| Poor sound or No sound. | <ul style="list-style-type: none"> • Station or Cable TV experiencing problems, tune to another station. • Check Volume adjustments. • Check for sources of possible interference. | 14 20 43 |
| Poor picture or No picture. | <ul style="list-style-type: none"> • Station or Cable TV experiencing problems, tune to another station. • Check antenna or Cable TV connections, reorient antenna. • Check for sources of possible interference. • Check picture control adjustments. | 14 14 43 26 |
| Poor reception on some channels. | <ul style="list-style-type: none"> • Station or Cable TV experiencing problems, tune to another station. • Station signal is weak, reorient antenna to receive weaker station. • Check for sources of possible interference. | 14 13,14 43 |
| Poor color or no color. | <ul style="list-style-type: none"> • Station or Cable TV experiencing problems, tune to another station. • Make sure channels are set into memory. • Check picture control adjustments. • Check antenna or Cable TV connections, reorient antenna. • Check for sources of possible interference. | 14 23 26 14 43 |
| Picture wobbles or drifts. | <ul style="list-style-type: none"> • Station or Cable TV experiencing problems, tune to another station. • Make sure channels are set into memory. • Cable TV company is scrambling signal. • Check antenna orientation. | 14 23 – 13 |
| No CATV reception. | <ul style="list-style-type: none"> • Check all Cable TV connections. • Set TV/CABLE selection to the CABLE position. • Station or Cable TV system problems, try another station. | 14 23 20 |
| Horizontal or diagonal bars on screen. | <ul style="list-style-type: none"> • Check antenna connections, reorient antenna. • Check for sources of possible interference. | 13,14 43 |
| No reception above channel 13. | <ul style="list-style-type: none"> • Make sure TV/CABLE selection is in the appropriate position. • If using antenna, check UHF antenna connections. | 23 13 |
| TV shuts off. | <ul style="list-style-type: none"> • No broadcast on station tuned. • Sleep Timer is set. • Power interrupted. | 23 21 – |
| Closed - Caption is not activated. | <ul style="list-style-type: none"> • TV station experiencing problems or program tuned is not closed captioned. Try another channel. • Check Cable TV connection or VHF/UHF antenna, reposition or rotate antenna. • Press CLOSED CAPTION button to turn on the closed caption decoder. | 20 13,14 22 |
| Display is not shown in your language. | <ul style="list-style-type: none"> • Select proper language in the menu options. | 19 |



| SYMPTOMS | POSSIBLE SOLUTIONS | PAGE |
|--|---|---------------|
| DVD | | |
| Playback doesn't start. | <ul style="list-style-type: none"> No disc is inserted. The disc may be dirty. Clean up the disc. The unit cannot play CD-ROMs, etc. | 28 7 8 |
| No picture. | <ul style="list-style-type: none"> TV/DVD selector is not set correctly. | 28 |
| No sound. | <ul style="list-style-type: none"> Check the input selector of the amplifier is set properly. The unit is in the special playback mode. Select the correct Audio Output position on AV amplifier. | – 30 15 |
| Picture is distorted during fast reverse/forward playback. | <ul style="list-style-type: none"> The picture will be distorted occasionally. | – |
| Stopping playback, search, slow-motion play, repeat play, or program play, etc. cannot be performed. | <ul style="list-style-type: none"> Some discs may not do some of the functions. | – |
| No 4:3 (16:9) picture. | <ul style="list-style-type: none"> Select appropriate screen size. | 39 |
| No on-screen display. | <ul style="list-style-type: none"> Select Display On. | 39 |
| No surround sound. | <ul style="list-style-type: none"> The setup does not match your stereo system. | 15 |
| The unit or remote operation key is not functioning. | <ul style="list-style-type: none"> Turn off the unit and unplug the AC power cord for several minutes, then replug it. | – |
| Playback does not start when the title is selected. | <ul style="list-style-type: none"> Check the RATING LEVEL setup. | 40 |
| Audio soundtrack and/or subtitle language is not changed when you play back a DVD. | <ul style="list-style-type: none"> Multilingual language is not recorded on the DVD disc. | 35 |
| No subtitle. | <ul style="list-style-type: none"> Some discs have no subtitles. Subtitles are cleared. Press the SUBTITLE button. | 35 |
| Angle cannot be changed. | <ul style="list-style-type: none"> Multi-angles are not recorded on the DVD disc. | 34 |
| “  ” appears on the screen. | <ul style="list-style-type: none"> The function is prohibited with the unit or the disc. | 30 |
| REMOTE CONTROL | | |
| The remote control does not function. | <ul style="list-style-type: none"> Aim at the remote control at the remote sensor. Operate within approx. 5 meters or reduce the light in the room. Clear the path of the beam. The batteries are weak. Replace the batteries. Check the batteries are inserted correctly. | 12 |

Others



Specifications

General

| | |
|----------------------|---|
| Power supply | AC 120 V 60 Hz |
| Power consumption | Operation: 90 W, Stand by: 5 W |
| Picture tube | Type 20 (508.0 mm diagonal) |
| Speaker | 3 inches (76.5 mm), 8 ohm x 2 |
| Audio output power | 2.5 W + 2.5 W |
| Weight | 48.5 lbs (22.0 kg) |
| Dimensions | Width: 19-6/8 inches (502 mm) Height: 20-3/16 inches (513 mm) Depth: 19-1/4 inches (489 mm) |
| Tuner | 181 channel freq. synthesized VHF 2-13 UHF 14-69 CATV 125 Channels |
| Antenna input | UHF/VHF: 75 Ω coaxial |
| Applicable disc | DVD (12 cm, 8 cm), CD (12 cm, 8 cm) |
| Frequency range | DVD: 4 Hz-22 kHz, CD: 4 Hz-20 kHz |
| Operating conditions | Temperature: 5°C-40°C (41°F-104°F), Operating status: Horizontal |

Input/Output

| | |
|--------------------------------|---|
| Video input | 1.0 V (p-p), 75 Ω, negative sync., pin jack x 1 |
| Audio input | -8 dBm, 50 kΩ, negative sync., pin jack (L/R) x 1 |
| Audio output (DIGITAL COAXIAL) | 0.5 V (p-p), 75 Ω, pin jack x 1 |

Supplied accessories

| | |
|-------------------------------------|---|
| Remote control (DC-FN20S) | 1 |
| Batteries (R03/AAA) | 2 |
| 300-75 Ω matching transformer | 1 |

- Designs and specifications are subject to change without notice.



Limited warranty

Toshiba America Consumer Products, L.L.C. ("TACP") makes the following limited warranties. These limited warranties extend to the original consumer purchaser or any person receiving this set as a gift from the original consumer purchaser and to no other purchaser or transferee .

Limited Ninety (90) Day Warranty

TACP warrants this product and its parts against defects in materials or workmanship for a period of ninety (90) days after the date of original retail purchase. During this period, TACP will repair a defective product or part, without charge to you. You must deliver the entire set to an Authorized TACP Service Station. You pay for all transportation and insurance charges for the set to and from the Service Station.

Limited One (1) Year Warranty

TACP further warrants the parts in this product against defects in materials or workmanship for a period of one year after the date of original retail purchase. During this period TACP will replace a defective part without charge to you, except that if a defective part is replaced after ninety (90) days from the date of original retail purchase you pay labor charges involved in the replacement. You must also deliver the entire product to a TACP Authorized Service Station. You are responsible for all transportation for the set to and from the Service Station.

Limited Two (2) Year Warranty of Picture Tube

TACP further warrants the picture tube in this product against defects in materials or workmanship for a period of two (2) years after the date of original retail purchase. During this period, TACP will replace a defective picture tube without charge to you except that if a defective picture tube is replaced after ninety (90) days from the date of the original retail purchase, you pay labor charges involved in the replacement. You are responsible for all charges involved in the replacement. You are responsible for all transportation and insurance charges for the set to and from the Service Station.

Rental Units

The warranty for rental units begins with the first rental or thirty (30) days from the date of shipment to the rental firm, whichever comes first.

Commercial Units

Products sold and used for commercial use have a limited ninety (90) day warranty for all parts, labor and picture tube.

Owner's Manual and Demographic Card

You should read this owner's manual thoroughly before operating this product. You should complete and mail the enclosed Demographic card within ten days after you, or the person who has given you this product as a gift, purchased this product. This is one way to enable TACP to provide you with better customer service and improved products. Failure to return the Demographic card will not affect your rights under this warranty.

Your Responsibility

The above warranties are subject to the following conditions:

- (1) You must retain your bill of sale or provide other proof of purchase.
- (2) All warranty servicing of this product must be made by an Authorized TACP Service Station.
- (3) These warranties are effective only if the product is purchased and operated in the U.S.A. or Puerto Rico.
- (4) Labor service charges for set installation, set up, adjustment of customer controls and installation or repair of antenna systems are not covered by this warranty. Reception problems caused by inadequate antenna systems are your responsibility.
- (5) Warranties extend only to defects in materials or workmanship as limited above and do not extend to any product or parts which have been lost or discarded by you or to damage to products or parts caused by misuse, accident, damage caused by Acts of God, such as lightning or fluctuations in electric power, improper installation, improper maintenance or use in violation of instructions furnished by us; or to units which have been altered or modified without authorization of TACP.

Others



Limited warranty (continued)

How to Obtain Warranty Service

If after following all of the operating instructions in this manual and checking the section "Troubleshooting" and you still find that service is needed;

- (1) Call the TACP toll free number 1-800-631-3811 after you find a defective product or part to find the nearest Toshiba Authorized Service Station.
- (2) Please present your bill of sale or other proof to the Authorized Service Station.
"TACP Authorized Service Station personnel will come to your home when warranty service is required. Depending on the type of repair required, the service will either be performed in your home or the set will be taken to the TACP Authorized Service Station for repair and returned to your home at no cost to you".

In the Continental United States contact:



All warranties implied by state law, including the implied warranties of merchantability and fitness for a particular purpose, are expressly limited to the duration of the limited warranties set forth above. With the exception of any warranties implied by state law as hereby limited, the foregoing warranty is exclusive and in lieu of all other warranties, guarantees, agreements and similar obligations of manufacturer or seller with respect to the repair or replacement of any parts. In no event shall TACP be liable for consequential or incidental damages.

No person, agent, distributor, dealer or company is authorized to change, modify or extend the terms of these warranties in any manner whatsoever. The time within which action must be commenced to enforce any obligation of TACP arising under this warranty or under any statute, or law of the United States or any state thereof, is hereby limited to 90 days from the date you discover or should have discovered, the defect. This limitation does not apply to implied warranties arising under state law.

This warranty gives you specific legal rights and you may also have other rights which may vary from state to state. Some states do not allow limitation on how long an implied warranty lasts, when an action may be brought, or the exclusion or limitation of incidental or consequential damages, so the above provisions may not apply to you.



ATTENTION CANADIAN CONSUMERS:

Canadian consumers are requested to complete the special Canadian "Warranty Registration Form" enclosed, and forward this completed form with a copy of bill of sale to TOSHIBA OF CANADA to "Register and Validate" their warranty.

Products purchased in the U.S.A. and used in Canada are not covered by these warranties.

Products purchased in Canada and used in the U.S.A. are not covered by these warranties.

Rev. 09-01-98

TOSHIBA

TOSHIBA AMERICA CONSUMER PRODUCTS, L.L.C.



04/03 U

J5K50101B